

# KNX Manual

## Application Description

### Presence Detector thePassa P360 KNX



## Inhaltsverzeichnis

1. Functional characteristics	4
1.1 thePassa P360 KNX presence detector	4
1.2 Features	4
1.3 Information about this document.	4
1.4 Technical data	5
1.4.1 Product overview	5
1.4.2 Dimensions	6
1.4.3 Detection area thePassa P360 KNX.	7
2. The application programme thePassa P360 KNX.	8
2.1 Selection in the product database	8
2.2 Parameter pages	8
2.3 Communication objects	9
2.3.1 Overview	9
2.3.2 Meaning of the flags	10
2.3.3 Object characteristics for lighting control.	11
2.3.4 Characteristics of the other objects.	14
2.4 Parameter	17
2.4.1 General information	17
2.4.2 Settings	18
2.4.3 Brightness measurement	19
2.4.4 Channel C1 light	20
2.4.5 Detail settings - Channel C1 Light - Switching.	22
2.4.6 Detail settings - Channel C1 Light - Constant lighting control	23
2.4.7 Detail settings - Channel C1 Light - Constant lighting control without depending on presence.	24
2.4.8 Channel C1 Light - block function.	26
2.4.9 Channel C2 light	26
2.4.10 Detail settings - Channel C2 Light - Switching.	28
2.4.11 Detail settings - Channel C2 Light - Constant lighting control	28
2.4.12 Detail settings - Channel C2 Light - Constant lighting control without depending on presence.	28
2.4.13 Channel C4, C5 Presence	29
2.4.14 Objects - Channel C4, C5 Presence.	29
2.4.15 Block function - Channel C4, C5 Presence.	30
2.4.16 Remote control.	30
2.4.17 Scenes	31
2.4.18 Scene functions	32
3. Manual operation with push buttons	32
3.1 Manual operation via switching function without dimmable lighting	32
3.2 Manual operation via switching function with dimmable lighting	33
3.3 Manual operation with constant lighting control function.	33
3.4 Manual operation with constant lighting control function without depending on presence	34
4. Parallel switching	35
4.1 Master/Slave parallel switching	35
4.2 Master/Master parallel switching.	35
4.3 Telegram load when using parallel switching	35
5. Aura effect function	36
6. Brightness setpoint value/constant lighting control	37

6.1	Setting the brightness setpoint value . . . . .	37
6.2	Calibration of brightness measurement . . . . .	37
6.3	Configuration of switching/dimming actuators and DALI gateways for constant lighting control . . . . .	39
6.3.1	Recommended configuration . . . . .	39
6.3.2	Actuators with separate object for status feedback (value) . . . . .	39
6.3.3	Actuators without separate object for status feedback (value) . . . . .	39
7.	Test modes . . . . .	40
7.1	Presence test . . . . .	40
7.2	Light test . . . . .	40
8.	User remote control theSenda S . . . . .	41
8.1	Performance characteristics of theSenda S . . . . .	41
8.2	Combining the presence detector and theSenda S . . . . .	41
8.3	Examples of set IR group addresses . . . . .	42
8.3.1	One presence detector, two lighting channels . . . . .	42
8.3.2	Two presence detectors, each with one lighting channel and blinds . . . . .	43
8.3.3	Two presence detectors, two lighting channels . . . . .	44
8.3.4	Two presence detectors with one and two internal lighting channels . . . . .	45
9.	theSenda B user remote control . . . . .	46
9.1	Performance characteristics of theSenda B . . . . .	46
9.2	Combining the presence detector and theSenda B . . . . .	47
9.3	Examples of set IR group addresses . . . . .	48
9.3.1	One presence detector, two lighting channels . . . . .	48
9.3.2	Two presence detectors, each with one lighting channel and blinds . . . . .	49
9.3.3	Two presence detectors, two lighting channels . . . . .	50
9.3.4	Two presence detectors with one and two internal lighting channels . . . . .	50
9.3.5	Two presence detectors, two lighting channels and blinds . . . . .	51
10.	Troubleshooting . . . . .	52
11.	Appendix . . . . .	53
11.1	Typical applications . . . . .	53
11.1.1	Presence and brightness-dependent switching of light . . . . .	53
11.1.2	Presence and brightness-dependent switching of light, additional manual override via push button . . . . .	54
11.1.3	Presence and brightness-dependent switching of light with two lighting groups in a room . . . . .	55
11.1.4	Presence and brightness-dependent switching with additional heating control . . . . .	57
11.1.5	Constant lighting control . . . . .	59
11.1.6	Constant lighting control, additional manual override via push button . . . . .	61
11.1.7	Constant lighting control with two lighting groups . . . . .	63
11.1.8	Master/Slave parallel switching . . . . .	65
11.1.9	Master/Master parallel switching . . . . .	66
11.1.10	Aura effect . . . . .	67

## 1. Functional characteristics

### 1.1 thePassa P360 KNX presence detector

The presence detector switches or controls a maximum of two lighting groups dependent on the presence of persons and the current brightness. The light outputs can be dynamically faded up and down by the integrator. The brightness switching value or setpoint value can be set via parameters, object, or the management remote control, the installation remote control, or the app remote control.

The lighting switches on with presence and insufficient brightness, and off with absence or sufficient brightness. Manual switching or dimming can be performed with a button.

When constant lighting control is active, the brightness is held constant at the brightness setpoint value. The control is started fully automatically or manually via push button or remote control. Manual switching off, dimming and scenes stop control for as long as the presence continues.

Up to 2 additional channels transmit the presence information in the room to further devices such as heating, ventilation, air-conditioning or blind controls. Each channel has a switch-on delay and a time delay.

The presence detector also has an integrated scene component as well as the possibility of processing scene numbers for the lighting groups. In combination with the remote control, the presence detector is not only capable of switching and dimming its own lighting groups, but also to control other external consumers such as lights, blinds, etc.

### 1.2 Features

- ◆ Passive infrared presence detector for ceiling installation
- ◆ Rectangular detection area with two detection zones of 15 x 5 m (total 30 x 5 m), which can be switched on and off separately
- ◆ Restriction of detection area with cover clips
- ◆ Automatic presence- and brightness-dependent control for lighting and HVAC
- ◆ Mixed light measurement suitable for fluorescent lamps (FL/PL/ESL), halogen/incandescent lamps and LEDs
- ◆ 2 directed light measurements
- ◆ 2 channels C1, C2 light with two light measurements
- ◆ Switching or constant lighting control with 2 independent control systems and standby function (orientation light)
- ◆ Switching mode with dimmable lighting
- ◆ Fully or semi-automatic device
- ◆ Brightness switching value or setpoint value can be set in lux by using parameters, object or remote control
- ◆ Teach-in of the brightness switching value or the setpoint value
- ◆ Light time delay can be set using parameters, object or remote control
- ◆ Reduction of time delay when present briefly (short-term presence)
- ◆ Aura effect function and walking direction recognition
- ◆ Manual override by telegram or remote control
- ◆ 2 presence channels C4 and C5 can be programmed individually
- ◆ Switch-on delay and presence time delay can be set
- ◆ Setting the room correction factor for brightness measurement calibration
- ◆ Adjustable detection sensitivity
- ◆ Extremely simple setting of the energy-saving response with the new "ECO plus" function
- ◆ Test mode for checking function and detection area
- ◆ Scene functionality
- ◆ Parallel switching of multiple presence detectors (Master/Slave or Master/Master)
- ◆ Ceiling installation in flush-mounting box
- ◆ Surface mounting on ceilings possible with back box (option)
- ◆ App remote control "theSenda B" (option) and corresponding app "theSenda Plug" (iOS/Android)
- ◆ Management remote control "SendoPro 868-A" (optional)
- ◆ Installation remote control "theSenda P" (option)
- ◆ User remote control "theSenda S" (option)

### 1.3 Information about this document



#### Style

- < ..... >            Parameter names  
 active..                The two dots at the end of the text in a parameter selection indicate that an additional parameter page will be opened.

#### Terminology

- Operating mode    Master  
                           Slave
- Configuration type    Fully automatic device  
                           Semi-automatic device
- Channel function    Switching  
                           Constant lighting control  
                           Constant lighting control without influence of presence

## 1.4 Technical data

Presence detector		thePassa P360 KNX
Number of light measurements (mixed light)		2
Recommended installation height		2.0 - 6.0 m (minimum height > 1.7 m)
Max. detection area		20 x 5 m (Mh. 3.5 m)/100 m <sup>2</sup> radially moving 30 x 5 m (IH 3.5 m)/150 m <sup>2</sup> moving tangentially
Detection angle	horizontal	360°
Operating voltage		Bus voltage KNX, max. 30 V
Power consumption		Approx. 8 mA/9 mA with LED on
Type of installation		Ceiling installation; flush/surface mounted or ceiling installation
Setting range of brightness switching value/setpoint value		10–3000 lux
Lighting time delay		30 s – 60 min
Presence time delay		10 s – 120 min
Presence switch-on delay		10 s – 30 min/not active
Standby dimming value		1 – 25% of the lamp output
Standby time		30 s–60 min/not active/permanently on
Remote control communication	Receiving data	IR
Parameter setting		All settings can be remotely controlled via ETS, as described in this document.
Connection type		Plug-in terminals, type WAGO 243
Protection rating		IP 20 (IP 54 when installed)
Ambient temperature		–15 °C – 50 °C
CE Declaration of Conformity		This device conforms to the regulations of the EMC Directive 2014/30/EC
RCM compliance		This device is compliant with the ACMA guidelines.

## 1.4.1 Product overview

Type of installation	Channel	Colour	Type	Item number
Ceiling installation	2 light   2 HVAC	White	thePassa P360 KNX UP WH	2019300
Ceiling installation	2 light   2 HVAC	Grey	thePassa P360 KNX UP GR	2019301
Ceiling installation	2 light   2 HVAC	Special colour in accordance with customer information	thePassa P360 KNX UP SF	2019303

Accessories	Item number
Back box 110A WH	9070912
Back box 110A GR	9070913
App remote control theSenda B/theSenda Plug	9070985
Management remote control SendoPro 868-A	9070675
Installation remote control theSenda P	9070910
User remote control theSenda S	9070911
Cover clip (5 pieces)	9070921
QuickSafe safety cover	9070531

1.4.2 Dimensions

thePassa P360 KNX

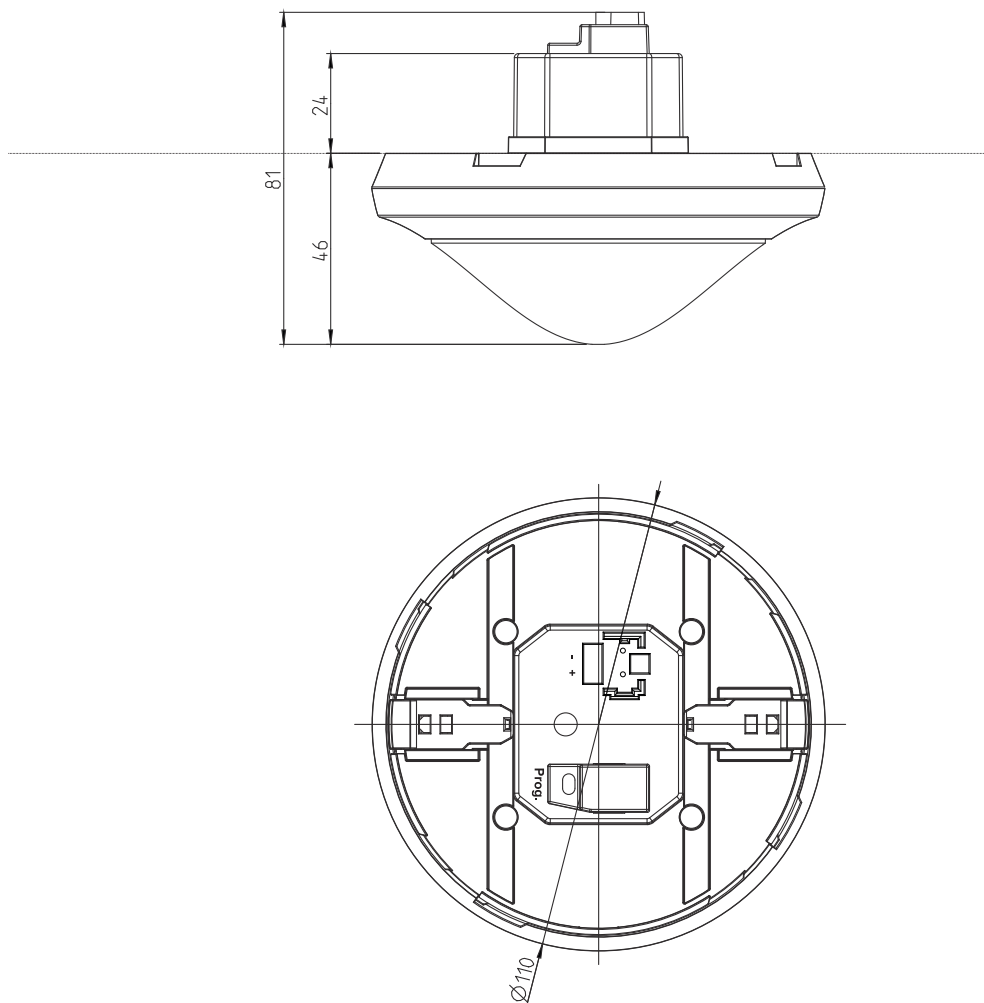

### 1.4.3 Detection area thePassa P360 KNX

The rectangular detection area of thePassa presence detector covers a large detection area, and permits a complete coverage of the corridor. It is possible that, in certain areas, the detection area is larger than stated. Please bear in mind that, based on the walking direction, the detection area is divided into different sectors. The recommended installation height is 2.0 m – 6.0 m. As installation height increases, the sensitivity of the presence detector decreases.

From an installation height of 3.5 m, the detection areas of several detectors should overlap in the marginal zones. The detection range is reduced as the temperature increases.

The detection area is divided into two zones. These can be easily activated or deactivated via ETS setting.

#### Detection areas: zone 1 and zone 2 (factory setting)

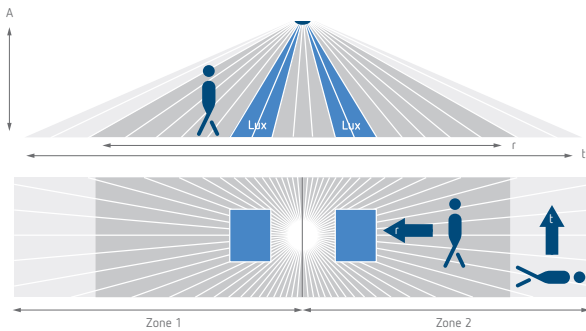

Installation height (A)	Walking persons frontal (r)	Walking persons across (t)
2.0 m	16 x 3.5 m (56 m <sup>2</sup> )	16 x 3.5 m (56 m <sup>2</sup> )
2.5 m	18 x 4 m (72 m <sup>2</sup> )	22 x 4 m (88 m <sup>2</sup> )
3.0 m	20 x 4.5 m (90 m <sup>2</sup> )	30 x 4.5 m (135 m <sup>2</sup> )
3.5 m	20 x 5 m (100 m <sup>2</sup> )	30 x 5 m (150 m <sup>2</sup> )
4.0 m	20 x 5 m (100 m <sup>2</sup> )	30 x 5 m (150 m <sup>2</sup> )
4.5 m	20 x 5 m (100 m <sup>2</sup> )	30 x 5 m (150 m <sup>2</sup> )
5.0 m	20 x 5 m (100 m <sup>2</sup> )	30 x 5 m (150 m <sup>2</sup> )
5.5 m	20 x 5 m (100 m <sup>2</sup> )	30 x 5 m (150 m <sup>2</sup> )
6.0 m	20 x 5 m (100 m <sup>2</sup> )	30 x 5 m (150 m <sup>2</sup> )

All figures are guidance values.

#### Detection areas: zone 1 or zone 2

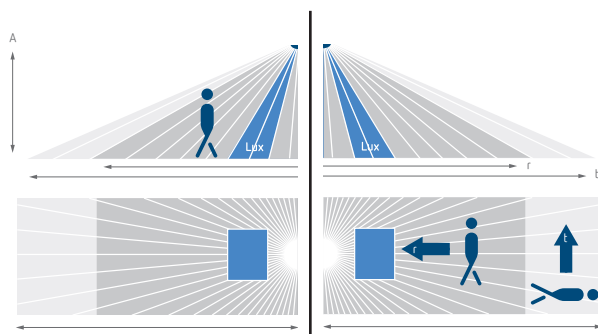

Installation height (A)	Walking persons frontal (r)	Walking persons across (t)
2.0 m	8 x 3.5 m (28 m <sup>2</sup> )	8 x 3.5 m (28 m <sup>2</sup> )
2.5 m	9 x 4 m (36 m <sup>2</sup> )	11 x 4 m (44 m <sup>2</sup> )
3.0 m	10 x 4.5 m (45 m <sup>2</sup> )	15 x 4.5 m (68 m <sup>2</sup> )
3.5 m	10 x 5 m (50 m <sup>2</sup> )	15 x 5 m (75 m <sup>2</sup> )
4.0 m	10 x 5 m (50 m <sup>2</sup> )	15 x 5 m (75 m <sup>2</sup> )
4.5 m	10 x 5 m (50 m <sup>2</sup> )	15 x 5 m (75 m <sup>2</sup> )
5.0 m	10 x 5 m (50 m <sup>2</sup> )	15 x 5 m (75 m <sup>2</sup> )
5.5 m	10 x 5 m (50 m <sup>2</sup> )	15 x 5 m (75 m <sup>2</sup> )
6.0 m	10 x 5 m (50 m <sup>2</sup> )	15 x 5 m (75 m <sup>2</sup> )

All figures are guidance values.

2. The application programme thePassa P360 KNX

2.1 Selection in the product database

	thePassa P360 KNX
Manufacturer	Theben AG
Product family	Physical sensors
Product type	Presence detector
Product name	thePassa P360 KNX

The KNX databases can be found on our website: <http://www.theben.de> or <http://www.theben-hts.ch>

2.2 Parameter pages

Name	Description
General	General settings, e.g. operating mode, etc.
Settings	Sensitivity, detection zone, etc.
Brightness measurement	Source brightness measurement, room correction factor, settings for sending the current brightness value via the bus
Channel C1 - light	Settings for lighting control of channel C1 light
Detail settings	Settings channel C1 light - Switching
Detail settings	Settings for channel C1 light - Constant lighting control
Detail settings	Settings for channel C1 light - Constant lighting control without depending on presence
Block function light	Settings for blocking channel C1/C2 light
Channel C2 - light	Settings for lighting control of channel C2 light
Detail settings	Settings channel C2 light - Switching
Detail settings	Settings channel C2 light - Constant lighting control
Detail settings	Settings channel C2 light - Constant lighting control without depending on presence
Block function light	Settings for blocking channel C2 light
Channel C4 - presence	Channel C4 for presence-dependent control of other systems, such as heating or air conditioning
Objects	Setting of telegrams
Block function presence	Settings for blocking channel C4 presence
Channel C5 - presence	Channel C5 for presence-dependent control of other systems, such as heating or air conditioning
Objects	Setting of telegrams
Block function presence	Settings for blocking channel C5 presence
Remote control	Settings for allocation of commands in the user remote control
Scenes	Definition of scenes in relation to user remote control
Scene functions	Definition of scene functions



## 2.3 Communication objects

### 2.3.1 Overview

The thePassa P360 KNX presence detector has 53 communication objects. In switching mode, the designation of setpoint value changes to switching value.

Object number	Object name	Function	Length	Data type (ID)	Flags				
					C	R	W	T	U
0	Channel C1 light	Switching	1 bit	1,001	√		√	√	
1	Channel C1 light	Brighter/darker	4 bit	3,007	√		√	√	
2	Channel C1 light	Send value	1 byte	5,001	√		√	√	
3	Channel C1 light	Feedback value	1 byte	5,001	√		√	√	√
4	Channel C1 brightness setpoint value	Receive value	2 bytes	9,004	√		√	√	
5	Channel C1 brightness setpoint value (teach-in)	\$01=call up/ \$81=save	1 byte	18,001	√		√		
6	Channel C1 alternative brightness setpoint value	Receive value	2 bytes	9,004	√		√	√	
7	Channel C1 measurement value on lux meter	Receive value	2 bytes	9,004	√		√		
8	Channel C1 room correction factor	Call up value	2 bytes	9.*	√	√		√	
9	Channel C1 brightness value	Send lux value	2 bytes	9,004	√	√		√	
10	Channel C1 external brightness value	Receive lux value	2 bytes	9,004	√		√		
11	Channel C2 light	Switching	1 bit	1,001	√		√	√	
12	Channel C2 light	Brighter/darker	4 bit	3,007	√		√	√	
13	Channel C2 light	Send value	1 byte	5,001	√		√	√	
14	Channel C2 light	Feedback value	1 byte	5,001	√		√	√	√
15	Channel C2 brightness setpoint value	Receive value	2 bytes	9,004	√		√	√	
16	Channel C2 brightness setpoint value (teach-in)	\$01=call up/ \$81=save	1 byte	18,001	√		√		
17	Channel C2 alternative brightness setpoint value	Receive value	2 bytes	9,004	√		√	√	
18	Channel C2 measurement value on lux meter	Receive value	2 bytes	9,004	√		√		
19	Channel C2 room correction factor	Call up value	2 bytes	9.*	√	√		√	
20	Channel C2 brightness value	Send lux value	2 bytes	9,004	√	√		√	
21	Channel C2 external brightness value	Receive lux value	2 bytes	9,004	√		√		
22	Channel C1 light	Selection of brightness setpoint value	1 bit	1,003	√		√		
23	Channel C2 light	Selection of brightness setpoint value	1 bit	1,003	√		√		
24	Channel C1, C2 light	Selection of constant lighting control	1 bit	1,003	√		√		
24	Channel C1, C2 light constant lighting control	Activate/deactivate	1 bit	1,003	√		√		
25	Channel C1, C2 light	Standby function	1 bit	1,003	√		√		
26	Channel C1, C2 light	Aura effect	1 bit	1,003	√		√		
27	Channel C1, C2 lighting time delay	Receive value	2 bytes	7,005	√		√	√	
28	Channel C1, C2 light	Block/unblock	1 bit	1,003	√		√		
29	Central command	Receive	1 bit	1,001	√		√		
30	External scene	Receive	1 byte	18,001	√		√		
31	Channel C4.1 presence	Switching	1 bit	1,001	√	√		√	
31	Channel C4.1 presence	Send value	1 byte	5,010	√	√		√	
31	Channel C4.1 presence	Send percentage value	1 byte	5,001	√	√		√	
31	Channel C4.1 presence	HVAC operating mode	1 byte	20,102	√	√		√	
31	Channel C4.1 presence	Send scene	1 byte	17,001	√	√		√	

32	Channel C4.2 presence	Switching	1 bit	1,001	√	√		√	
32	Channel C4.2 presence	Send value	1 byte	5,010	√	√		√	
32	Channel C4.2 presence	Send percentage value	1 byte	5,001	√	√		√	
32	Channel C4.2 presence	HVAC operating mode	1 byte	20,102	√	√		√	
32	Channel C4.2 presence	Send scene	1 byte	17,001	√	√		√	
Object number	Object name	Function	Length	Data type (ID)	Flags				
					C	R	W	T	U
33	Channel C4 presence	Block/unblock	1 bit	1,003	√		√		
34	Channel C5.1 presence	Switching	1 bit	1,001	√	√		√	
34	Channel C5.1 presence	Send value	1 byte	5,010	√	√		√	
34	Channel C5.1 presence	Send percentage value	1 byte	5,001	√	√		√	
34	Channel C5.1 presence	HVAC operating mode	1 byte	20,102	√	√		√	
34	Channel C5.1 presence	Send scene	1 byte	17,001	√	√		√	
35	Channel C5.2 presence	Switching	1 bit	1,001	√	√		√	
35	Channel C5.2 presence	Send value	1 byte	5,010	√	√		√	
35	Channel C5.2 presence	Send percentage value	1 byte	5,001	√	√		√	
35	Channel C5.2 presence	HVAC operating mode	1 byte	20,102	√	√		√	
35	Channel C5.2 presence	Send scene	1 byte	17,001	√	√		√	
36	Channel C5 presence	Block/unblock	1 bit	1,003	√		√		
38	Parallel switching zone 1/2	Trigger input/output	1 bit	1,017	√		√	√	
38	Channel C1 aura effect	Send motion status	2 bytes	7,005	√		√	√	
39	Parallel switching zone 2	Trigger input/output	1 bit	1,017	√		√	√	
39	Channel C2 aura effect	Send motion status	2 bytes	7,005	√		√	√	
40	Walking direction recognition zone 1	Send motion status	1 bit	1,017	√			√	
41	Walking direction recognition zone 2	Send motion status	1 bit	1,017	√			√	
42	Scene input	Scene 1/2	1 bit	1,022	√		√		
42	Scene output	Scene number	1 byte	18,001	√			√	
43	IR external switching/dimming 1	Switching	1 bit	1,001	√			√	
44	IR external switching/dimming 1	Brighter/darker	4 bit	3,007	√			√	
45	IR external switching/dimming 2	Switching	1 bit	1,001	√			√	
46	IR external switching/dimming 2	Brighter/darker	4 bit	3,007	√			√	
47	IR external blinds 1	Blinds up/down	1 bit	1,008	√			√	
48	IR external blinds 1	Open/close slats	1 bit	1,009	√			√	
49	IR external blinds 2	Blinds up/down	1 bit	1,008	√			√	
50	IR external blinds 2	Open/close slats	1 bit	1,009	√			√	
51	Test mode presence	On/Off	1 bit	1,001	√		√		
52	Test mode light	On/Off	1 bit	1,001	√		√		
53	Software version	Send	2 bytes	217,001	√	√		√	

### 2.3.2 Meaning of the flags

Flag	Flag name	Description
C	Communication	Object can communicate
R	Read	Object value can be read (ETS/display, etc.)
W	Write	Object can receive
T	Transmit	Object can send
U	Update	Object can overwrite

### 2.3.3 Object characteristics for lighting control

In switching mode, the designation of setpoint value changes to switching value.

Object	Object name	Function	Description
Object 0	Channel C1 light	Switching	In "switching" mode, the switch output C1 light sends an ON telegram upon detection of motion and insufficient brightness, and an OFF telegram upon the expiration of the time delay or with sufficient brightness: 0 = Absence or sufficient brightness (OFF) 1 = Presence and insufficient brightness (ON)
Object 0 Object 1 Object 2 Object 3	Channel C1 light Channel C1 light Channel C1 light Channel C1 light	Switching Brighter/darker Send value Feedback value	Objects 1 - 3 are available if "yes" has been selected in the "Constant lighting control" function or in "Switching mode" <Lighting dimmable in switching mode>. In the "Constant lighting control" function, objects 0 - 3 are used for constant lighting control. All four objects must be linked for a functioning constant lighting control. A different response is produced depending on configuration. The constant lighting control can be started with a value or an ON telegram. For further details see page 23 chapter 2.4.6. In the "Constant lighting control" or "Constant lighting control without presence" function, constant lighting control can also be used without presence. The use independently of presence can be activated and deactivated via object 24. The presence detector does not have any specific push button inputs, but does respond to push button commands sent to objects 0 to 2. The response under manual control can be selected as either "school" or "office". Please observe the information on push button operation on page 32 chapter 3.
Object 4  Object 15	Channel C1 brightness setpoint value  Channel C2 brightness setpoint value	Receive value	Object available if "yes" has been selected at <Set brightness setpoint value via bus>. This enables changing of the brightness setpoint value during operation. The received brightness setpoint value is set to the corresponding limit automatically if it lies outside the value range (10..3000 lux) or the brightness setpoint value does not match the current room correction factor setting (see setting limit). Object 4/15 returns the stored value of the brightness setpoint value. When changing the brightness setpoint value via remote control, the new value is sent. In switching mode, value "0" means "Measurement OFF".
Object 5  Object 16	Channel C1 brightness setpoint value (teach-in)  Channel C2 brightness setpoint value (teach-in)	\$01=call up/ \$81=save	Object available if "yes" has been selected at <Set brightness setpoint value via bus>. Via a value telegram \$81 (129), the presence detector accepts the currently measured brightness value [lux] as new brightness setpoint value or the alternative brightness setpoint value (depending on which one is currently active). For example, if the presence detector switches to the alternative brightness setpoint value, the currently measured brightness value [lux] is transferred to the alternative brightness setpoint value via value telegram \$81 (129). Object 4/15 sends the saved value of the currently active brightness setpoint value, or object 6/17 sends the alternative brightness setpoint value (depending on which is active at the time). Object 4/15 sends the current brightness setpoint value via value telegram \$01 (1), or object 6/17 if the alternative brightness setpoint value is active. Transfer is made to the currently active brightness setpoint value.

Object	Object name	Function	Description
Object 6  Object 17	Channel C1 alternative brightness setpoint value  Channel C2 alternative brightness setpoint value	Receive value	Object available if "yes" has been selected at <Set alternative brightness setpoint value via bus>.  This enables resetting of the alternative brightness setpoint value during operation. The received brightness setpoint value is adjusted to the corresponding limit automatically if it lies outside the value range (10..3000 lux) or the brightness setpoint value does not match the current room correction factor setting (see setting limit). Object 6/17 returns the stored value of the alternative brightness setpoint value. When changing the alternative brightness setpoint value with the app remote control "theSenda B" ("theSenda Plug" app), or management remote control "SendoPro 868-A", the new value is sent. In switching mode, value "0" means "Measurement OFF".
Object 7  Object 18	Channel C1 measurement value on lux meter  Channel C2 measurement value on lux meter	Receive value	Object available if "yes" has been selected at <Set brightness measurement value via bus>.  The measured lux meter value is needed to calculate the room correction factor. The lux meter is placed on the work surface below the sensor and the measured lux value is sent via object 7/18, app remote control "theSenda B" ("theSenda Plug" app), or management remote control "SendoPro 868-A".  The room correction factor is calculated automatically immediately after entry. Object 8/19 sends the stored value (scale factor 100).
Object 8  Object 19	Channel C1 room correction factor  Channel C2 room correction factor	Call up value	Object available if "yes" has been selected at <Set brightness measurement value via bus>.  The room correction factor is calculated automatically following the entry of the lux meter value, or it is entered via ETS. Permissible values lie between 0.05 and 2.0. Calculated or entered values outside the permitted range will automatically be set to the appropriate limit value.  For monitoring purposes, the room correction factor can be queried via object 8 for channel C1 light, or object 19 for channel C2 light (scale factor 100).
Object 9  Object 20	Channel C1 brightness value  Channel C2 brightness value	Send lux value	Object available if "yes" has been selected at <Send brightness value via bus>.  The presence detector sends the currently measured brightness value as a 2-byte telegram via object 9/20. The frequency of telegrams depends on the cycle time and the minimum change in brightness.  The 2-byte telegrams to object 9/20 are used to visualise a brightness value. Using the presence detector's internal constant lighting control function is recommended for control.  The brightness value will be adapted to the conditions inside the room with the room correction factor. See page 19 chapter 2.4.3
Object 10  Object 21	Channel C1 external brightness value  Channel C2 external brightness value	Receive lux value	Object available if "external" has been selected at <Brightness measurement source>.  As an alternative to internal light measurement, an external brightness value can be used via object 10 for channel C1, or object 21 for channel C2.
Object 11	Channel C2 light	Switching	If two switch outputs are used, object 11 is used for brightness-dependent switching of channel C2 light.  Function, see object 0: Channel C1 light: Switching.
Object 11 Object 12 Object 13 Object 14	Channel C2 light Channel C2 light Channel C2 light Channel C2 light	Switching Brighter/darker Send value Feedback value	Objects 12 - 14 are available if the "Constant lighting control" function or "yes" in "Switching mode" <Lighting dimmable in switching mode> has been selected.  If two channels are used, objects 11-14 are used for control or constant lighting control of channel C2 light.  Function, see objects 0 - 3: Channel C1 light.

Object	Object name	Function	Description
Object 22	Channel C1 light	Selection of brightness setpoint value	Object available if "active" has been selected at <Selection of brightness setpoint value>.
Object 23	Channel C2 light	Selection of brightness setpoint value	Depending on the configuration, it is possible to switch between two brightness setpoint values for daylight-dependent switching or constant lighting control. - An ON telegram to bus object 22/23 switches to the alternative brightness setpoint value. - An OFF telegram switches back to the original base brightness setpoint value as setpoint value. This applies to both switching and constant lighting control.
Object 24	Channel C1 light Channel C1/C2 light	Selection of constant lighting control	Object available if <Lighting channel C1 function> "constant lighting control" has been selected. Response when using "Constant lighting control": - ON telegram to object 24 starts the presence-independent control. The <configuration type> of the lighting channel is automatically switched to "fully automatic device". - OFF telegram to object 24 deactivates the presence-independent control and presence-dependent constant lighting control is resumed. The set <configuration type> will be restored.
	Channel C1 light constant lighting control Channel C1/C2 light constant lighting control	Activate/deactivate	Object available if <Lighting channel C1 function> "presence-independent constant lighting control" has been selected. Response when using "Presence-independent constant lighting control": - ON telegram to object 24 starts the control. - OFF telegram to object 24 deactivates the control and switches the lighting off. The 2 lighting channels C1/C2 can be switched and dimmed separately.
Object 25	Channel C1 light Channel C1/C2 light	Standby function	The standby function is available if "active" has been selected at <Lighting standby time>. The standby function can be deactivated and reactivated via object 25. The standby function is activated by default.
Object 26	Channel C1 light Channel C1/C2 light	Aura effect	Object available if "Aura effect" has been selected at <Master operating mode>. The aura effect function can be deactivated and reactivated via object 26. The aura effect function is activated by default.
Object 27	Channel C1 lighting time delay Channel C1/C2 lighting time delay	Receive value	Object available if "yes" has been selected at <Set lighting time delay via bus>. The time delay can be set jointly for channels C1, C2 light in a range of 30 s to 60 s via object. 27. The value must be sent in seconds. In the range of 2 to 30 minutes, the lighting time delay is adjusted adaptively, except if <Energy saving mode> is set to "ECO plus".
Object 28	Channel C1 light Channel C1/C2 light	Block/unblock	Object available if "yes" has been selected at <Activate block function>. The channels light are blocked jointly with an ON or OFF telegram. At the start of the blocking process, the light outputs optionally send one of the following telegrams: ON, OFF, no telegram, value X%. During the blocking, the channels do not send any telegrams, neither on the basis of presence/absence nor on the basis of brightness. The channels light are unblocked via an ON or OFF telegram, complementing the telegram when blocking. When unblocking, the detector always sends the current status and thereby continues the brightness-dependent switching or constant lighting control.

Object	Object name	Function	Description
Object 29	Central command	Receive	<p>An ON telegram switches the channels C1, C2 light on. The response of the presence detector is as if the user switches it on via a push button. The response depends on the selected control type. See chapter 3 page 32.</p> <p>An OFF telegram switches the channels C1, C2 light according to the following conditions:</p> <ul style="list-style-type: none"> <li>- no movement within the last 5 seconds: The light switches off immediately. The running time delays for channels C1, C2 light and standby time are set to 0. The presence detector then returns to normal operation.</li> <li>- If &lt;Duration of standby time light&gt; is set to "on", channels C1, C2 are not switched off, but instead switch to the set standby operation.</li> <li>- Motion when receiving the OFF telegram: The light stays on.</li> </ul> <p><b>Fully automatic device:</b></p> <ul style="list-style-type: none"> <li>- If further movement is detected subsequently, the light is switched on again if there is insufficient brightness.</li> </ul> <p><b>Presence detector is blocked</b></p> <ul style="list-style-type: none"> <li>- The central command is not executed.</li> </ul>
Object 30	External scene	Receive	<p>Object available if "inactive" has not been selected at &lt;Channel C1 light function&gt; or at &lt;Channel C2 light function&gt;.</p> <p>Scene numbers sent directly to the actuator can be directed to the presence detector to block/unblock the lighting channels of the presence detector, to deactivate/activate control, or to use internal scene 1/2.</p> <p>See page 32 chapter 2.4.18.</p>

### 2.3.4 Characteristics of the other objects

Object	Object name	Function	Description
Object 31 Object 32 Object 34 Object 35	Channel C4.1 presence Channel C4.2 presence Channel C5.1 presence Channel C5.2 presence	Switching Send value Send percentage value HVAC operating mode Send scene	<p>Object available if "active.." has been selected at &lt;Channel C4.X presence&gt; or "active.." at &lt;Channel C5.X presence&gt;.</p> <p>Channel C4, C5 presence sends the configured telegram (independently of brightness after a potential delay due to the configured switch-on delay) or no telegram if there is a presence. After the time delay has elapsed, either the configured telegram or no telegram at all will be sent. The telegram type is freely selectable.</p>
Object 33 Object 36	Channel C4 presence Channel C5 presence	Block/unblock	<p>Object available if "yes" has been selected at &lt;Activate block function&gt;.</p> <p>The channel presence is disabled via an ON or OFF telegram. The response at the start of blocking can be defined as follows:</p> <ul style="list-style-type: none"> <li>- no response</li> <li>- as if presence detected</li> <li>- as at the end of the time delay</li> </ul> <p>The channel presence is unblocked via an ON or OFF telegram, complementing the telegram when blocking. After unblocking, the current state is sent.</p>

Object	Object name	Function	Description
Object 38  Object 39	Parallel switching zone 1  Parallel switching zone 1/2  Parallel switching zone 2	Trigger input/output	<p>Object available if "Parallel switching" has been selected at &lt;Master operating mode&gt;, or if &lt;Operating mode&gt; "Slave" has been selected.</p> <p>The trigger input/output is required for parallel switching of several presence detectors. There are two possible types of switching:</p> <p>Master/Slave parallel switching: A Master receives the motion information from several Slaves in the room and switches or controls the lighting as required on the basis of the brightness measured by the Master. The advantage is uniform switching with a defined brightness value. For applications in corridors for example, the Master is installed in the darkest position.</p> <p>Master-Master parallel switching: Several Masters exchange the motion information among each other. The advantage is a zone with uniform presence detection but with several light measurements, for example 3 lighting groups in a room, where the group nearest to the window can be dimmed much darker than the lighting groups in the interior of the room.</p> <p>Each detector sends a maximum of two ON telegrams per minute on detection of motion. The interval (cycle time) between two telegrams can be set to a maximum of 4 minutes. Please keep in mind to always select the interval between two trigger telegrams to be shorter than the time delay.</p> <p>Please observe the information on parallel switching in chapter 4, page 35.</p>
Object 38  Object 39	Channel C1 aura effect  Channel C2 aura effect	Send motion status	<p>Object available if "Aura effect" has been selected at &lt;Master operating mode&gt;. At &lt;Channel C1/C2 light function&gt; "Switching light..", &lt;Lighting dimmable in switching mode&gt; "yes" has also to be selected, in order for objects 38/39 to be displayed.</p> <p>With presence and the lighting switched on in the corresponding detection zone, the detector sends a time value telegram with the set &lt;Cycle time aura effect&gt; via the corresponding object 38/39 to the adjacent detection zones.</p> <p>If in a detection zone a time value telegram is received via the corresponding object 38/39 and at the same time no one is present in this detection zone, then the aura effect is started, i.e. the lighting will be switched on to the set &lt;Aura dimming value&gt;. If the lighting is switched off, the aura effect will only be started in switching mode or in constant lighting control if there is insufficient brightness, or in switching mode always with "Measurement off" for the brightness switching value.</p> <p>If standby operation is active, it will be overridden by the aura effect. After the aura effect has ended, standby operation will be resumed.</p> <p>An application example with the aura effect can be found in chapter 11.1.10, from page 67.</p>
Object 40  Object 41	Walking direction recognition zone 1  Walking direction recognition zone 2	Send motion status	<p>Object available if "zone 1 and zone 2 together" or "zone 1 and zone 2 separately" has been selected at &lt;Detection zone&gt;.</p> <p>If motion is detected in the corresponding detection zone, an ON telegram will be sent via bus object 40 (zone 1)/41 (zone 2). As soon as motion is no longer detected, an OFF telegram will be sent after at least 5 s. Proper evaluation allows the realisation of a walking direction recognition.</p>
Object 42	Input/output scene	Scene 1/2  Scene number	<p>Depending on the chosen configuration, internal scenes can be called up via object 42, or scenes can be directly controlled.</p> <p>Internal scenes: Object 42 becomes the "Scene input" if "Use internal scenes" has been selected at &lt;Scene controls&gt;.</p> <p>An OFF telegram to the scene input object calls up scene 1, an ON telegram calls up scene 2.</p> <p>Object 42 becomes the "Scene output" if "Send scene number to bus" has been selected at &lt;Scene controls&gt;.</p> <p>When the scene buttons  on the user remote control theSenda B or theSenda S are pressed, the scene output object sends the set scene number.</p>

Object	Object name	Function	Description																								
Object 43 Object 44	IR external switching/dimming 1 IR external switching/dimming 1	Switching  Brighter/darker	<p>If an IR group address is allocated to the &lt;Switching/dimming external 1&gt; parameter, objects 43 and 44 assume the following function, as soon as a command with the selected IR group address is received:</p> <p>Briefly pressing the /🔌 push buttons causes a ON telegram (1) or an OFF telegram (0) to be sent via object 43 switching. Holding down the  button on the remote control causes "dim brighter" to be sent via object 44, and "stop" when released. Holding down the  button on the remote control causes "dim darker" to be sent via object 44, and "stop" when released.</p>																								
Object 45 Object 46	IR external switching/dimming 2 IR external switching/dimming 2	Switching  Brighter/darker	<p>If an IR group address is allocated to the &lt;Switching/dimming external 2&gt; parameter, objects 45 and 46 assume the same function as objects 43/44, as soon as a command with the selected IR group address is received.</p>																								
Object 47 Object 48	IR external blinds 1 IR external blinds 1	Blinds up/down Open/close slat	<p>If an IR group address is allocated to the &lt;External blinds 1&gt; parameter, objects 47 and 48 assume the following function, as soon as a command with the selected IR group address is received:</p> <p>Briefly pressing the /🔌 buttons causes a 0 or 1 telegram to be sent via the object "Open/close slats". Holding down the /🔌 buttons causes a 0 or 1 telegram to be sent via the object "Blinds up/down".</p>																								
Object 49 Object 50	IR external blinds 2 IR external blinds 2	Blinds up/down Open/close slat	<p>If an IR group address is allocated to the &lt;External blinds 2&gt; parameter, objects 49 and 50 assume the same function as described with object 47/48, as soon as a command with the selected IR group address is received.</p>																								
Object 51	Test mode presence	On/Off	<p>An ON telegram activates test mode presence for the duration of the configured time. See page 40 chapter 7 for a description of test mode presence An OFF telegram ends test mode presence early and the detector restarts.</p>																								
Object 52	Test mode light	On/Off	<p>An ON telegram activates test mode light for the duration of the configured time. See page 40 chapter 7 for a description of the test mode light An OFF telegram ends test mode light early and the detector restarts.</p>																								
Object 53	Software version	Send	<p>The software version of the presence detector can be queried via this object. The format of the queried software version corresponds to data type 217.001.</p> <table border="1" style="margin-left: auto; margin-right: auto;"> <thead> <tr> <th>Info (DPT 217.001)</th> <th>Software version</th> </tr> </thead> <tbody> <tr><td>08 00</td><td>1.00</td></tr> <tr><td>08 40</td><td>1.01</td></tr> <tr><td>08 80</td><td>1.02</td></tr> <tr><td>08 C0</td><td>1.03</td></tr> <tr><td>09 00</td><td>1.04</td></tr> <tr><td>09 40</td><td>1.05</td></tr> <tr><td>09 80</td><td>1.06</td></tr> <tr><td>09 C0</td><td>1.07</td></tr> <tr><td>0A 00</td><td>1.08</td></tr> <tr><td>0A 40</td><td>1.09</td></tr> <tr><td>0A 80</td><td>1.10</td></tr> </tbody> </table>	Info (DPT 217.001)	Software version	08 00	1.00	08 40	1.01	08 80	1.02	08 C0	1.03	09 00	1.04	09 40	1.05	09 80	1.06	09 C0	1.07	0A 00	1.08	0A 40	1.09	0A 80	1.10
Info (DPT 217.001)	Software version																										
08 00	1.00																										
08 40	1.01																										
08 80	1.02																										
08 C0	1.03																										
09 00	1.04																										
09 40	1.05																										
09 80	1.06																										
09 C0	1.07																										
0A 00	1.08																										
0A 40	1.09																										
0A 80	1.10																										



## 2.4 Parameter

Default values appear in bold.

### 2.4.1 General information

Parameter name	Values	Meaning															
Operating mode	<p><b>Master</b></p> <p>Slave</p>	<p>A Master is capable of lighting control (switching or constant lighting control) and forwarding the presence information.</p> <p>Slaves are used to extend the detection area. They supply presence information to the Master.</p> <p>The &lt;Parallel switching cycle time&gt; parameter is displayed.</p> <p>Please observe the information on parallel switching in chapter 4 page 35.</p>															
Detection zone	<p>only zone 1</p> <p>only zone 2</p> <p><b>Zone 1 and zone 2 together</b></p> <p>Zone 1 and zone 2 separately</p>	<p>The detection area is divided into two independent detection zones (see page 7, chapter 1.4.3 Detection area). For a maximum range, zone 1 and zone 2 are activated. If a limitation of the detection area is required, zone 1 or zone 2 can be deactivated.</p> <p>With the &lt;detection zone&gt; parameter, the desired detection zones can be selected. Depending on the selected the detection zone, the lighting channels C1/C2 and their brightness measurement are active as follows:</p> <table border="1"> <thead> <tr> <th>&lt;Detection zone&gt; parameter</th> <th>Lighting channel</th> <th>Brightness measurement</th> </tr> </thead> <tbody> <tr> <td>only zone 1</td> <td>Channel C1</td> <td>Zone 1</td> </tr> <tr> <td>only zone 2</td> <td>Channel C2</td> <td>Zone 2</td> </tr> <tr> <td>Zone 1 and zone 2 together</td> <td>Channel C1</td> <td>Average of zone 1 and zone 2</td> </tr> <tr> <td>Zone 1 and zone 2 separately</td> <td>Channel C1/C2</td> <td>Zone 1/zone 2</td> </tr> </tbody> </table>	<Detection zone> parameter	Lighting channel	Brightness measurement	only zone 1	Channel C1	Zone 1	only zone 2	Channel C2	Zone 2	Zone 1 and zone 2 together	Channel C1	Average of zone 1 and zone 2	Zone 1 and zone 2 separately	Channel C1/C2	Zone 1/zone 2
<Detection zone> parameter	Lighting channel	Brightness measurement															
only zone 1	Channel C1	Zone 1															
only zone 2	Channel C2	Zone 2															
Zone 1 and zone 2 together	Channel C1	Average of zone 1 and zone 2															
Zone 1 and zone 2 separately	Channel C1/C2	Zone 1/zone 2															
Master operating mode	<p><b>Individual switching</b></p> <p>Parallel switching</p> <p>Aura effect</p>	<p>Presence detector works as an independent device.</p> <p>Parallel switching: If required, the detection area can be extended by connecting additional detectors to a "Master" as "Slaves", or several "Masters" can be connected with each other.</p> <p>The &lt;Parallel switching cycle time&gt; parameter is displayed.</p> <p>Please observe the information on parallel switching in chapter 4 page 35.</p> <p>Aura effect: The light surrounds the user while he is moving. The lighting in the adjacent detection areas is switched or dimmed to the &lt;Aura dimming value&gt;.</p> <p>The &lt;Aura effect cycle time&gt; parameter is displayed. The aura effect function is not possible in combination with constant lighting control without influence of presence. Please observe the information on the aura effect in chapter 5 on page 36.</p>															
Cycle time parallel switching	<p><b>30 seconds</b></p> <p>1 minute</p> <p>2, 3, 4 minutes</p>	<p>Each detector sends a maximum of two ON telegrams per minute when detecting motion. The interval between two telegrams can be set at up to 4 minutes to reduce the number of telegrams.</p> <p>Please keep in mind to always select the interval between two trigger telegrams to be shorter than the time delay.</p>															
Cycle time aura effect	<p><b>30 seconds</b></p> <p>5 s ... 5 minutes</p>	<p>With presence and the lighting switched on in the corresponding detection zone, the detector cyclically sends a time value telegram.</p>															
Function channel C1 light	<p><b>Switching light</b></p> <p>Constant lighting control</p> <p>Constant lighting control without influence of presence</p> <p>inactive</p>	<p>Channel C1 light switches a lighting group depending on the presence of persons and the current brightness level.</p> <p>Channel C1 light controls a lighting group depending on the presence of persons and the current brightness level.</p> <p>Channel C1 light controls a lighting group depending on the current brightness level. In &lt;Master operating mode&gt;, "Aura effect" not possible.</p> <p>The presence detector is not used for lighting control.</p>															

Parameter name	Values	Meaning
Function channel C2 light	Switching light	Channel C2 light switches a lighting group depending on the presence of persons and the current brightness level.
	Constant lighting control	Channel C2 light controls a lighting group depending on the presence of persons and the current brightness level.
	Constant lighting control without influence of presence	Channel C2 light controls a lighting group depending on the current brightness level. In <Master operating mode>, "Aura effect" not possible.
	inactive	Channel C2 light is not used. The associated parameters and objects are not displayed.
Function channel C4 presence	active	The "Channel C4 presence" parameter page is displayed. Channel C4 presence switches other devices, such as HVAC systems depending on the presence of persons, or it delivers the presence information to higher-level systems (independently of brightness).
	inactive	The presence detector is not used for controlling HVAC applications.
Function channel C5 presence	active	The "Channel C5 presence" parameter page is displayed. Channel C5 presence switches other devices, such as HVAC systems depending on the presence of persons, or it delivers the presence information to higher-level systems (independently of brightness).
	inactive	The presence detector is not used for controlling HVAC applications.
Activation of test mode	via object or remote control, max. 30 min	An activated test mode will automatically be ended after the set time has elapsed, and the detector will be restarted. See page 40 chapter 7 for the description of the test modes.
	2 – 60 min	

### 2.4.2 Settings

Parameter name	Values	Meaning
Detection sensitivity	1–5	The detector has 5 sensitivity levels: 1 very insensitive 2 insensitive 3 standard 4 sensitive 5 very sensitive By selecting the presence test mode, the set sensitivity increment is not changed.
	3 standard	The basic setting is the middle increment (3).
Parameter settings at download	overwrite via download	The setting affects the following parameters: - Brightness setpoint value of channel C1, C2 light - Alternative brightness setpoint value of channel C1, C2 light - Lighting time delay - Room correction factor - Detection sensitivity - Scene values  The relevant parameter values (see above) in the presence detector will be overwritten. Settings modified with app remote control "theSenda B ("theSenda Plug" app), "SendoPro 868-A" management remote control, "theSenda P" installation remote control, or via bus object will be lost.  The parameters set in the ETS are accepted.
	unchanged via download	The relevant parameter values (see above) in the presence detector remain unchanged. Settings modified with app remote control "theSenda B ("theSenda Plug" app), "SendoPro 868-A" management remote control, "theSenda P" installation remote control, or via bus object will remain unchanged.  <b>Note: With the first download (factory setting) or after discharging the detector, valid parameter values have to be downloaded first, otherwise error flashing will be displayed.</b>
Motion indicated by the LED	no	No display of motion. LED is switched off.
	yes	As soon as motion is detected, the LED illuminates. The LED remains on as long as motion is detected.

2.4.3 Brightness measurement

Parameter name	Values	Meaning
Brightness measurement source	internal external	The presence detector measures the artificial light and daylight by means of an internal light measurement. The brightness value must be supplied via object 10/21. The optimum cycle time is about 1 s, or at changes greater than 5%.
Light measurement selection channel C1	Use light measurement of zone 1	Depending on the selected the detection zone, the light measurements are dedicated to the corresponding lighting channel.
Light measurement selection channel C2	Use light measurement of zone 2 Use light measurement integral	Integral forms the average of the 2 light measurements in zone 1 and zone 2. <b>Note: During installation, pay attention to the orientation of the presence detector! Further information can be found in the operating manual.</b>
Room correction factor channel C1 Room correction factor channel C2	0.05–2   0.3	The room correction factor is a measurement for the difference between the brightness measurement at the ceiling and on the work area. The brightness measurement value at the ceiling is influenced by the installation location, incidence of light, position of the sun, weather conditions, the reflection properties of the room, and the furniture. The room correction factor allows the brightness measurement taken by the presence detector to be adapted to the conditions in the room. In this way, the brightness value measured by the presence detector can be scaled to the lux meter value measured on the surface below the presence detector. Separate room correction factors are available for each light measurement. Standard value, suitable for most applications.  <b>Adjustment of the brightness measurement value of the detector</b> Method, see 6.2 Calibration of brightness measurement, page 37.
Set brightness measurement value via bus	yes  no	Objects 7/18 measurement value on lux meter and objects 8/19 room correction factor are displayed. The brightness measurement value cannot be set via the bus.
Send brightness value on bus	yes  no	The measured brightness value is sent as a 2-byte telegram via bus object 9/20. The measured brightness value can be adjusted to the conditions in the room with the <Room correction factor> parameter. The parameters "Transmit brightness value cyclically" and "Transmit brightness value upon change" are displayed. Note: If the brightness value is used for external control, please note that <Transmit brightness value cyclically> is set to 5 s and <Transmit brightness value upon change> is set to > 5%. The measured brightness value is not transmitted.
Send brightness value cyclically	5 s .... 30 min every 1 min no	The measured brightness value is transmitted cyclically at the selected time. Standard value The measured brightness value is not transmitted cyclically.
Send brightness value upon change	>5% ... >80%  from >30% no	The brightness value is sent if the measured value has changed by at least the configured value since the last transmission. This change is independent of the length of time taken for this process. If the brightness remains constant, the brightness value will be resent on completion of the configured cycle time. With frequent changes in brightness, the value is sent not earlier than 5 seconds after the last transmission. This time setting cannot be changed. Standard value The measured brightness value is not transmitted depending on a change in brightness.

2.4.4 Channel C1 light

Parameter name	Values	Meaning
Configuration type	<p><b>Fully automatic device</b></p> <p>Semi-automatic device</p>	<p>In the "fully automatic device" &lt;configuration type&gt;, the lighting channel automatically switches or controls the lighting depending on presence and surrounding brightness. It is switched off automatically.</p> <p>In the "semi-automatic device" &lt;configuration type&gt;, switching on must always be initiated manually via push button or remote control. Exception: If motion is detected within 10 seconds after the time delay has expired, the light comes on automatically. It is switched off automatically.</p> <p>See also page 32 chapter 3.</p>
Brightness switching value Brightness setpoint value	<p>10–3000 lx</p> <p><b>200 lx</b></p> <p>Measurement off (depending on presence only)</p>	<p>Switching light: The brightness switching value defines the minimum desired brightness. The currently prevailing brightness is measured underneath the presence detector. If the prevailing brightness is below the switching value, the light is switched on as soon as a presence is detected.</p> <p>Constant lighting control: The defined brightness setpoint value is achieved by controlling/dimming the lamps (objects 1 - 3).</p> <p>The brightness switching/setpoint value is adjustable in increments between 10–3000 lx.</p> <p>Standard value.</p> <p>Switching light:</p> <ul style="list-style-type: none"> <li>- The brightness switching value can be deactivated by means of the setting "Measurement off (depending on presence only)".</li> </ul> <p>Management remote control "SendoPro 868-A", app remote control "theSenda B/theSenda Plug", or installation remote control "theSenda P" provide assistance when setting the brightness switching/setpoint value.</p> <p>Note: If the brightness switching/setpoint value does not match the currently set room correction factor (see setting limit), the brightness switching/setpoint value is set to the corresponding limit automatically.</p>
Set brightness switching/setpoint value via bus	<p>yes</p> <p>no</p>	<p>Bus objects 4 and 5 are visible and can be used.</p> <p>Bus objects 4 and 5 are not available.</p> <p>Note: The brightness switching/setpoint value can always be set with the remote control.</p>
Lighting time delay	<p>30 s – 60 min</p> <p><b>10 min</b></p>	<p>The time delay can be set between 30 seconds and 60 minutes. Each detected motion restarts the time delay.</p> <p>The time delay adjusts to the user behaviour by self-learning. It can increase automatically to max. 30 minutes or decrease back to the set minimum time. The time delay does not change through self-learning with a setting &lt;=2 minutes or &gt;=30 minutes, or if &lt;Energy saving mode&gt; is set to "ECO plus".</p> <p>The time delay applies jointly to all channels C1, C2 light.</p>
Set lighting time delay via bus	<p>yes</p> <p>no</p>	<p>The time delay can be set via the bus. Bus object 27 is available.</p> <p>The time delay can be set only via remote control.</p>
Energy saving mode	<p><b>ECO</b></p> <p>ECO plus</p>	<p>The selection "ECO" assures optimal switching response of the presence detector. The time delay adjusts to the user behaviour by self-learning. It does not drop below the set value.</p> <p>The selection "ECO plus" assures maximum energy savings. The set time delay remains unchanged, no self-learning effect. The control speed is increased.</p>
Short-term presence	<p>inactive</p> <p><b>active</b></p>	<p>The lighting channel time delay can be switched off sooner if a room is occupied for only a short time. (In fully automatic device and semi-automatic device configuration type)</p> <p>The time delay is used according to the set parameter.</p> <p>If someone enters an unoccupied room and it is only occupied for up to 30 seconds, the light is switched off earlier, after 2 minutes.</p> <p>Short-term presence is also applied if a push button is used to switch on the lights.</p>

Parameter name	Values	Meaning
Selection of brightness switching/setpoint value	<p><b>inactive</b></p> <p><b>active</b></p>	<p>There is only one brightness switching/setpoint value (basis) available.</p> <p>A second, alternative brightness setpoint value can be configured. During normal operation, it can be switched between both of these brightness setpoint values.</p> <p>Bus object 22 is visible and can be used.</p> <ul style="list-style-type: none"> <li>- An ON telegram to the relevant bus object switches to the alternative brightness setpoint value.</li> <li>- An OFF telegram restores the original value. This applies to both switching and constant lighting control.</li> </ul> <p>Example: Implementation of day and night operation with two different brightness levels.</p>
Alternative brightness switching/setpoint value	<p>10–3000 lx</p> <p>100 lx</p> <p>Measurement off</p>	<p>The parameter is visible if &lt;Selecting brightness switching/setpoint value&gt; is active. During operation, bus object 22 can be used to switch between the brightness switching/setpoint values.</p> <p>The alternative brightness switching/setpoint value can be set in increments between 10–3000 lux. Standard value</p> <p>Note: If the alternative brightness switching/set point value does not match the currently set room correction factor (see setting limit), the alternative brightness switching/set point value is set to the corresponding limit automatically.</p> <p>The presence detector operates only depending on presence. (possible only with the "Switching light" function)</p>
Set alt. brightness switching/setpoint value via bus	<p><b>yes</b></p> <p><b>no</b></p>	<p>Parameter only available if "active" has been selected at &lt;Selecting brightness switching/setpoint value&gt;.</p> <p>Bus object 6 is visible and can be used.</p> <p>Bus object 6 is not available.</p> <p>Note: The brightness switching/setpoint value can always be set with the remote control.</p>

### 2.4.5 Detail settings - Channel C1 Light - Switching

The parameter page is visible if "Switching light" is set at the parameter <Function channel C1 light>. See page 17 chapter 2.4.1.

Parameter name	Values	Meaning
Lighting dimmable when in switching operation	yes  no	The lighting can be dimmed manually. The parameter "Duration of manual override" is displayed. Bus objects 1 - 3 are visible and can be used.  The lighting cannot be dimmed manually.
Duration of manual override	until lighting time delay has expired  15 min - 120 min	The parameter is visible if "yes" has been set at the parameter <Lighting dimmable when in switching operation>. The set dimming value applies until the time delay has elapsed. Afterwards, automatic operation will start.  The set dimming value applies until the set time or the time delay has elapsed. Afterwards, automatic operation will start.
Aura dimming value	1% – 25% 10%	The parameter is visible if "Aura effect" has been set at the parameter <Master operating mode>. The dimming values for the aura effect can be selected in increments from 1% to 25%. Standard value
Lighting standby time	inactive active	The parameter is visible if "yes" has been set at the parameter <Lighting dimmable when in switching operation>. The standby function is not available.  The standby function is available and the parameters are displayed.
Duration of lighting stand-by time	30 s – 60 min  30 min ON	The parameter is visible if "active" has been set at the parameter <Lighting standby time>. The standby time causes both lighting groups to dim to the set standby dimming value instead of switching off, when the time delay has elapsed. The standby time can be set between 30 seconds and 60 minutes. Standard value  With standby on, the lighting remains permanently on standby. If the brightness level in the rooms exceeds the brightness setpoint value, the lighting is switched off after 10 minutes in <Energy saving mode> on "ECO", and after 5 minutes in <Energy saving mode> on "ECO plus". Without presence, the lighting automatically returns to the standby value if the room brightness falls below the brightness setpoint value. This guarantees a minimum level of lighting in darkness.
Standby dimming value	1% – 25% 10%	The parameter is visible if "active" has been set at the parameter <Lighting standby time>. The dimming values for standby can be selected in increments from 1% to 25%. Standard value
Send channel C1 output value cyclically	every 1 min. ... 60 min  no	Current channel C1 output value is sent cyclically at the selected time. Note: If the lighting is dimmed brighter/darker (dimmable lighting) or manually switched off with a push button or with the remote control, the output value will NOT be transmitted cyclically anymore!
Activate block function	yes  no	Blocking channel C1 light means that the presence detector does not send telegrams via objects 0 to 3, although the evaluation of motion and brightness continues. Standard value

### 2.4.6 Detail settings - Channel C1 Light - Constant lighting control

The parameter page is visible if "Constant lighting control" is set at the parameter <Function channel C1 light>. See page 17 chapter 2.4.1.

Parameter name	Values	Meaning
Start of control with	Value telegram	Control is started with a value telegram. The actuator dims up the lights at the set dimming time.
	ON telegram	Control is started with an ON telegram. The actuator switches on and turns up the lights abruptly or gradually to the value configured on the actuator.
Start behaviour of control	with 4 bit stop telegram	<p>If a "value telegram" has been selected at &lt;Start of control with&gt;, a value telegram with the maximum value of the parameter "control range" will be sent. The actuator dims up the lights at its set dimming time.</p> <p>If an "ON telegram" has been selected at &lt;Start of control with&gt;, an ON telegram will be sent. The actuator dims up the lights to its switch-on value, at its set dimming time. The detector measures the rising brightness and stops the dimming process once the brightness setpoint value has been reached. Control starts at this point.</p>
	without 4 bit stop telegram	<p>If "value telegram" has been selected at &lt;Start of control with&gt;, control starts with the set parameter value "switch-on dimming value".</p> <p>If "ON telegram" has been selected at &lt;Start of control with&gt;, control starts with the switch-on value set on the actuator. Example: If a switch-on value of 70% is configured on the actuator, control starts with this switch-on value.</p>
Switch-on dimming value	30% ... 100%	<p>The parameter is visible if parameter &lt;Start of control with&gt; is set to "value telegram", and parameter &lt;Start behaviour of control&gt; to "without 4 bit stop telegram".</p> <p>When the controller starts, the lighting is switched on to the set &lt;switch-on dimming value&gt;, and control starts from this value.</p>
	70%	Standard value
Control speed	Standard	This parameter is used to change the increment of the sent dimming value. Behaviour is set to its optimum level. The change happens gradually and is almost imperceptible.
	Moderate	The change happens with a somewhat larger increment.
	Fast	The change happens with a large increment. The increment size depends on the brightness actual value and brightness setpoint value. The maximum increment size is 2% for standard, 3% for moderate and 8% for fast.
Control range	Standard	Control range: 10% to 100%.
	User-defined	The upper and lower limits of the control range can be user-defined. The parameters <Lower control limit> and <Upper control limit> are displayed.
Lower control limit	1% .. 25%	
	10%	Standard value
Upper control limit	70% .. 100%	
	100%	Standard value
Switching off when there is enough brightness	never switch off after 5 min ... 9 h	<p>If the lighting is controlled down to the lower limit, the lighting will be switched off after the time set at the parameter &lt;Switch off when there is enough brightness&gt;. With the selection „never switch off“, the lighting will never be switched off.</p> <p>This behaviour is valid, as long as people are present.</p>
	after 10 min	Standard value
Response with manual dimming	Office	Constant lighting control remains active temporarily after manual dimming to the current brightness value as the new setpoint value. After the time delay has expired, the originally configured set point value is restored.
	School	Constant lighting control is temporarily interrupted by manual dimming. The setpoint remains unchanged.

Parameter name	Values	Meaning
Aura dimming value	1% – 25% 10%	The parameter is visible if "Aura effect" has been set at the parameter <Master operating mode>. The dimming values for the aura effect can be selected in increments from 1% to 25%. Standard value
Lighting standby time	inactive active	The standby function for channel C1 light is not available. The standby function for channel C1 light is available and the parameters are displayed.
Duration of lighting standby time	30 s – 60 min  30 min ON	The parameter is visible if "active" has been set at the parameter <Lighting standby time>. The standby time causes both lighting groups to dim to the set standby dimming value instead of switching off, when the time delay has elapsed. The standby time can be set between 30 seconds and 60 minutes. Standard value With standby on, the lighting remains permanently on standby. If the brightness level in the rooms exceeds the brightness setpoint value, the lighting is switched off after 10 minutes in <Energy saving mode> on "ECO", and after 5 minutes in <Energy saving mode> on "ECO plus". Without presence, the lighting automatically returns to the standby value if the room brightness falls below the brightness setpoint value. This guarantees a minimum level of lighting in darkness.
Standby dimming value	1% – 25% 10%	The parameter is visible if "active" has been set at the parameter <Lighting standby time>. The dimming values for standby can be selected in increments from 1% to 25%. Standard value.
Send channel C1 output value cyclically	every 1 min. ... 60 min  no	Current channel C1 output value is sent cyclically at the selected time. Note: If the lighting is dimmed brighter/darker (dimnable lighting) or manually switched off with a push button or with the remote control, the output value will NOT be transmitted cyclically anymore!
Activate block function	yes  no	Blocking channel C1 light means that the presence detector does not send telegrams via objects 0 to 3, although the evaluation of motion and brightness continues. Standard value

#### 2.4.7 Detail settings - Channel C1 Light - Constant lighting control without depending on presence

The parameter page is visible if "Constant lighting control without depending on presence" is set at the parameter <Function channel C1 light>. See page 17 Kapitel 2.4.1.

Parameter name	Values	Meaning
Start of control with	Value telegram  ON telegram	Control is started with a value telegram. The actuator dims up the lights at the set dimming time. Control is started with an ON telegram. The actuator switches on and turns up the lights abruptly or gradually to the value configured on the actuator.
Start behaviour of control	with 4 bit stop telegram    without 4 bit stop telegram	If a "value telegram" has been selected at <Start of control with>, a value telegram with the maximum value of the parameter "control range" will be sent. The actuator dims up the lights at its set dimming time. If an "ON telegram" has been selected at <Start of control with>, an ON telegram will be sent. The actuator dims up the lights to its switch-on value, at its set dimming time. The detector measures the rising brightness and stops the dimming process once the brightness setpoint value has been reached. Control starts at this point.  If "value telegram" has been selected at <Start of control with>, control starts with the set parameter value "switch-on dimming value". If "ON telegram" has been selected at <Start of control with>, control starts with the switch-on value set on the actuator. Example: If a switch-on value of 70% is configured on the actuator, control starts with this switch-on value.



Parameter name	Values	Meaning
Switch-on dimming value	30% ... 100%  70%	The parameter is visible if parameter <Start of control with> is set to "value telegram", and parameter <Start behaviour of control> to "without 4 bit stop telegram". When the controller starts, the lighting is switched on to the set <switch-on dimming value>, and control starts from this value. Standard value
Control speed	Standard  Moderate  Fast	This parameter is used to change the increment of the sent dimming value. Behaviour is set to its optimum level. The change happens gradually and is almost imperceptible. The change happens with a somewhat larger increment. The change happens with a large increment. The increment size depends on the brightness actual value and brightness setpoint value. The maximum increment size is 2% for standard, 3% for moderate and 8% for fast.
Control range	Standard  User-defined	Control range: 10% to 100%. The upper and lower limits of the control range can be user-defined. The parameter page <Lower control limit> and <Upper control limit> is displayed.
Lower control limit	1% .. 25%  10%	Standard value
Upper control limit	70% .. 100%  100%	Standard value
Switching off when there is enough brightness	never switch off after 5 min ... 9 h    after 10 min	If the lighting is controlled down to the lower limit, the lighting will be switched off after the time set at the parameter <Switch off when there is enough brightness>. With the selection „never switch off“, the lighting will never be switched off. This behaviour is valid, as long as people are present. Standard value
Response with manual dimming	Office    School	Constant lighting control remains active after manual dimming to the new setpoint value. After the controller has been deactivated via object 24, the originally configured setpoint value is restored. Constant lighting control is interrupted by manual dimming until the controller is activated again via object 24. The setpoint remains unchanged.
Send channel C1 output value cyclically	every 1 min. .. 60 min    no	Current channel C1 output value is sent cyclically at the selected time. Note: If the lighting is dimmed brighter/darker (dimnable lighting) or manually switched off with a push button or with the remote control, the output value will NOT be transmitted cyclically anymore!
Activate block function	yes    no	Blocking channel C1 light means that the presence detector does not send telegrams via objects 0 to 3, although the evaluation of motion and brightness continues. Standard value

### 2.4.8 Channel C1 Light - block function

The parameter page is visible if "yes" has been set at the channel C1 detail settings parameter <Activate block function>.

Parameter name	Values	Meaning
Block telegram	<p>blocking with ON telegram</p> <p>Blocking with OFF telegram</p>	<p>Blocking the outputs of channel C1 light means that the presence detector does not send telegrams via objects 0 to 3, although the evaluation of motion and brightness continues. Note: Switching on/off and dimming are still possible with the user remote control.</p> <p><b>General unblocking</b> If no person is present in the room and in the last 30 seconds no trigger telegram has been received via parallel switching object 38/39, the lighting time delay is set to 0 upon unblocking. This causes the lighting to be switched off immediately or to be dimmed to the standby dimming value (standby time active). If no person is present in the room and in the last 30 seconds a trigger telegram has been received via parallel switching object 38/39, the lighting time delay is set to 30 seconds upon unblocking. If no more movements are detected, the lighting is switched off once the time delay expires or is set to the standby dimming value (standby time active). The lighting is not switched off if motion is detected with insufficient brightness.</p> <p>Channel C1 light is blocked with an ON telegram to the block object. All telegrams are suppressed for the duration of the blocking. Channel C1 light is unblocked with an OFF telegram. After unblocking, the detector sends the current status or continues the constant lighting control.</p> <p>The output C1 light is blocked with an OFF telegram and unblocked with an ON telegram.</p>
Response at start of blocking	<p>ON telegram</p> <p>OFF telegram</p> <p>no telegram</p> <p>send X% value</p>	<p>An ON telegram is sent at the start of blocking.</p> <p>An OFF telegram is sent at the start of blocking.</p> <p>No telegram is sent at the start of blocking.</p> <p>Moreover, a value between 10% and 100% can be sent in switching mode with dimmable lighting or in constant lighting control. The current status is always sent after unblocking, for instance, an ON telegram with absence and insufficient brightness in switching mode.</p>

### 2.4.9 Channel C2 light

The parameter page is visible if "Master" is set at the parameter <Operating mode>, "only zone 2" or "zone 1 and zone 2 separately" is set at parameter <Detection zone> and if <Channel C2 light function> is not set to "inactive". See page 17 chapter 2.4.1.

Parameter name	Values	Meaning
Configuration type	<p>Fully automatic device</p> <p>Semi-automatic device</p> <p>same as channel C1 light</p>	<p>In case &lt;Detection zone&gt; parameter is set to "zone 2": In the "fully automatic device" &lt;configuration type&gt;, the lighting channel automatically switches or controls the lighting depending on presence and surrounding brightness. It is switched off automatically.</p> <p>In the "semi-automatic device" &lt;configuration type&gt;, switching on must always be initiated manually via push button or remote control. Exception: If motion is detected within 10 seconds after the time delay has expired, the lighting is automatically switched on. It is switched off automatically. See also page 32, chapter 3.</p> <p>In case &lt;Detection zone&gt; parameter is set to "zone 1 and zone 2 separately": The configuration type for channel C2 light is adopted from channel C1 light.</p>
Brightness switching value Brightness setpoint value		<p>Switching light: The brightness switching value defines the minimum desired brightness. The currently prevailing brightness is measured underneath the presence detector. If the prevailing brightness is below the switching value, the light is switched on as soon as a presence is detected.</p> <p>Constant lighting control: The defined brightness setpoint value is set by controlling/dimming the lamps (objects 12 - 14)</p>

Parameter name	Values	Meaning
	10–3000 lx 200 lx Measurement off (depending on presence only)	<p>The brightness switching/setpoint value is adjustable in increments between 10–3000 lx.</p> <p>Standard value.</p> <p>Switching light:</p> <ul style="list-style-type: none"> <li>- The brightness switching value can be deactivated by means of the setting "Measurement off (depending on presence only)".</li> </ul> <p>Management remote control "SendoPro 868-A", app remote control "theSenda B/theSenda Plug", or installation remote control "theSenda P" provide assistance when setting the brightness switching/setpoint value.</p> <p>Note: If the brightness switching/setpoint value does not match the currently set room correction factor (see setting limit), the brightness switching/setpoint value is set to the corresponding limit automatically.</p>
Set brightness switching/ setpoint value via bus	yes  no	<p>Bus objects 15 and 16 are visible and can be used.</p> <p>Bus objects 15 and 16 are not available.</p> <p>Note: The brightness switching/setpoint value can always be set with the remote control.</p>
Lighting time delay	30 s – 60 min 10 min  same as channel C1 light	<p>In case &lt;Detection zone&gt; parameter is set to "zone 2":</p> <p>The time delay can be set between 30 seconds and 60 minutes. Each detected motion restarts the time delay.</p> <p>The time delay adjusts to the user behaviour by self-learning. It can increase automatically to max. 30 minutes or decrease back to the set minimum time.</p> <p>The time delay does not change through self-learning with a setting <math>\leq 2</math> minutes or <math>\geq 30</math> minutes, or if &lt;Energy saving mode&gt; is set to "ECO plus".</p> <p>The time delay applies to channel C2 light.</p> <p>In case &lt;Detection zone&gt; parameter is set to "zone 1 and zone 2 separately": The time delay for channel C2 light is adopted from channel C1 light.</p>
Set lighting time delay via bus	yes  no	<p>The time delay can be set via the bus. Bus object 27 is available.</p> <p>The time delay can be set only via remote control.</p>
Energy saving mode	ECO  ECO plus  same as channel C1 light	<p>In case &lt;Detection zone&gt; parameter is set to "zone 2":</p> <p>The selection "ECO" assures optimal switching response of the presence detector. The time delay adjusts to the user behaviour by self-learning. It does not drop below the set value.</p> <p>The selection "ECO plus" assures maximum energy savings. The set time delay remains unchanged, no self-learning effect. The control speed is increased.</p> <p>In case &lt;Detection zone&gt; parameter is set to "zone 1 and zone 2 separately": The energy saving mode for channel C2 light is adopted from channel C1 light.</p>
Short-term presence	inactive  active  same as channel C1 light	<p>The lighting channel time delay can be switched off sooner if a room is occupied for only a short time. (In fully automatic device and semi-automatic device configuration type)</p> <p>In case &lt;Detection zone&gt; parameter is set to "zone 2":</p> <p>The time delay is used according to the set parameter.</p> <p>If someone enters an unoccupied room and it is only occupied for up to 30 seconds, the light is switched off earlier, after 2 minutes.</p> <p>Short-term presence is also applied if a push button is used to switch on the lights.</p> <p>In case &lt;Detection zone&gt; parameter is set to "zone 1 and zone 2 separately": The short-term presence for channel C2 light is adopted from channel C1 light.</p>
Selection of brightness switching/setpoint value	inactive	<p>There is only one brightness switching/setpoint value (basis) available.</p>

Parameter name	Values	Meaning
	active	A second, alternative brightness setpoint value can be configured. During normal operation, it can be switched between both of these brightness setpoint values. Bus object 23 is visible and can be used. - An ON telegram to the relevant bus object switches to the alternative brightness setpoint value. - An OFF telegram restores the original value. This applies to both switching and constant lighting control. Example: Implementation of day and night operation with two different brightness levels.
Alternative brightness switching/setpoint value	10–3000 lx 100 lx  Measurement off	The parameter is visible if <Selecting brightness switching/setpoint value> is active. During operation, bus object 23 can be used to switch between the brightness switching/setpoint values. The alternative brightness switching/setpoint value can be set in increments between 10–3000 lux. Standard value Note: If the alternative brightness switching/set point value does not match the currently set room correction factor (see setting limit), the alternative brightness switching/set point value is set to the corresponding limit automatically. The presence detector operates only depending on presence. (possible only with the "Switching light" function)
Set alt. brightness switching/setpoint value via bus	yes  no	Parameter only available if "active" has been selected at <Selecting brightness switching/setpoint value>. Bus object 17 is visible and can be used. Bus object 17 is not available. Note: The brightness switching/setpoint value can always be set with the remote control.

#### 2.4.10 Detail settings - Channel C2 Light - Switching

The parameters are visible if "Switching light" is set at parameter <Function channel C2 light>. See page 17, chapter 2.4.1.

In case <Detection zone> parameter is set to "zone 2":

All settings for channel C2 light are possible. See page 22, chapter 2.4.5 "Detail settings - Channel C1 Light - Switching"

In case <Detection zone> parameter is set to "Zone 1 and zone 2 separately":

All settings for channel C2 light are adopted from channel C1 light.

#### 2.4.11 Detail settings - Channel C2 Light - Constant lighting control

The parameters are visible if "Constant lighting control" is set at the parameter <Function channel C2 light>. See page 17, chapter 2.4.1.

In case <Detection zone> parameter is set to "zone 2":

All settings for channel C2 light are possible. See page 23, chapter 2.4.6 "Detail settings - Channel C1 Light - Constant lighting control"

In case <Detection zone> parameter is set to "Zone 1 and zone 2 separately":

All settings for channel C2 light are adopted from channel C1 light.

#### 2.4.12 Detail settings - Channel C2 Light - Constant lighting control without depending on presence

The parameters are visible if "Constant lighting control without depending on presence" is set at the parameter <Function channel C2 light>. See page 17, chapter 2.4.1.

In case <Detection zone> parameter is set to "zone 2":

All settings for channel C2 light are possible. See page 24, chapter 2.4.7 "Detail settings - Channel C1 Light - Constant lighting control without depending on presence"

In case <Detection zone> parameter is set to "Zone 1 and zone 2 separately":

All settings for channel C2 light are adopted from channel C1 light.

### 2.4.13 Channel C4, C5 Presence

The parameter page is visible if "active" is set at the parameter <Function channel C4 presence> or <Function channel C5 presence>. See page 17 chapter 2.4.1.

Parameter name	Values	Meaning
Presence switch-on delay	inactive  10 s – 30 min	An inactive switch-on delay means the presence channel switches immediately when detecting motion.  A switch-on delay between 10 seconds and 30 minutes can be set for the presence channel. The presence channel does not switch immediately upon detection of motion, but only after the switch-on delay has expired.  The switch-on delay can be set separately for each channel C4, C5.  Example: A switch-on delay of 2 minutes can be set if the presence channel is used for controlling a fan in a toilet. The fan does not switch on if the toilet is briefly occupied, a longer presence of over 2 minutes switches the fan on.
Presence time delay	10 s – 120 min  15 min	The presence time delay can be set between 10 seconds and 120 minutes. It is restarted with every new motion.  The time delay can be set separately for each channel C4, C5.

### 2.4.14 Objects - Channel C4, C5 Presence

The parameter page is visible if "active" is set at the parameter <Function channel C4 presence> or <Function channel C5 presence>. See page 17 chapter 2.4.1.

Parameter name	Values	Meaning
Telegram type C4.1, C4.2 Telegram type C5.1, C5.2	Switch command Value Percentage value HVAC operating mode Scene	5 telegram types are available for selection
When presence detected At the end of the time delay	send cyclically send following telegram once do not send telegram	Channel C4, C5 presence is switched on only by presence without the influence of brightness.  A telegram is sent cyclically on detection of motion or at the end of the time delay. By default, a telegram is sent once on detection of motion or at the end of the time delay.  No telegram is sent on detection of motion or at the end of the time delay.
Telegram on switch command	Off, On On Off	Select at <Telegram type C4.1, C4.2, C5.1, C5.2> "Switch command" Standard value (when presence detected) Standard value (at the end of the time delay)
Telegram at value	0...255 255 0	Select at <Telegram type C4.1, C4.2, C5.1, C5.2> "Value" Standard value (when presence detected) Standard value (at the end of the time delay)
Telegram with percentage value	0% ... 100% 100% 0%	Select at <Telegram type C4.1, C4.2, C5.1, C5.2> "Percentage value" Standard value (when presence detected) Standard value (at the end of the time delay)
Telegram with HVAC operating mode	Comfort  Standby Temperature reduction at night Frost/heat protection	Select at <Telegram type C4.1, C4.2, C5.1, C5.2> "HVAC operating mode". These have the following byte values: comfort: 1; standby: 2; temperature reduction at night: 3; frost/heat protection: 4. Standard value (when presence detected) Standard value (at the end of the time delay)

Parameter name	Values	Meaning
Telegram with scene	Scene 1 ... 64 Scene 1 Scene 2	Select at <Telegram type C4.1, C4.2, C5.1, C5.2> "Scene" Standard value telegram (when presence detected) Standard value telegram (at the end of the time delay)
Should a second telegram be sent?	no yes	Standard value In addition to telegram C4.1 or C5.1, a second telegram C4.2 or C5.2 is sent. The telegrams and parameters available are the same as for C4.1 and C5.1.
Cycle time (if used)	every 1 ... 60 min every 60 min	Select the cycle time for cyclical transmission. Standard value
Activate block function	yes.. no	Blocking channels C4 and C5 presence stops the transmission of their telegrams. Channels C4, C5 presence are not blocked by default. The telegrams are transmitted on detection of motion and after the time delay elapses according to configuration.

### 2.4.15 Block function - Channel C4, C5 Presence

The parameter page is visible if "yes" has been set at the parameter <Activate block function>.

Parameter name	Values	Meaning
Block telegram	blocking with ON telegram Blocking with OFF telegram	Both channels C4, C5 presence are blocked via an ON telegram and unblocked with an OFF telegram. The presence detector sends its current status after unblocking. Both channels C4, C5 presence are blocked via an OFF telegram and unblocked with an ON telegram. The presence detector sends its current status after unblocking.
Response at start of blocking	no response as if presence detected as at the end of the time delay	No response after blocking. Once the channels are blocked, the presence detector responds as when presence is detected. Once the channels are blocked, the presence detector responds as at the end of the time delay.

### 2.4.16 Remote control

#### Allocation of IR group addresses

The IR group address of the presence detector and theSenda S, theSenda B user remote control must match so that the channels light or external channels can be operated. For detailed information on the application of IR group addresses see page 41, chapter 8 "theSenda S user remote control", or page 46, chapter 9 "theSenda B user remote control". In the ETS, the same IR group address must be defined as the one set on theSenda B or theSenda S user remote control.

Parameter name	Values	Meaning
Channel C1 - light Channel C2 - light External switching/dimming 1 External switching/dimming 2 External blinds 1 External blinds 2	inactive  I , II , III, IV, V, VI, VII, VIII	No IR group address was assigned to the relevant channel, and it cannot be influenced by the user remote controls theSenda B and theSenda S.  An IR group address is allocated to the respective channel. The channel reacts to the commands from the user remote controls theSenda B and theSenda S.

2.4.17 Scenes

Parameter name	Values	Meaning
Scene controls	<p>Using internal scenes</p> <p>Send scene number on bus</p> <p>inactive</p>	<p>The presence detector has a simple, internal scene component. A scene is used to store values (On, Off with switching operating mode, percentage values with constant lighting control) for the light outputs.</p> <p><b>End</b></p> <ul style="list-style-type: none"> <li>- Absent</li> <li>- Switch on light by using a button or user remote control theSenda B or theSenda S</li> </ul> <p>The &lt;Set scenes with&gt; parameter is displayed.</p> <p>The scenes can be called up by pressing the scene buttons on theSenda B or theSenda S user remote control, or via a telegram to the scene object 30 (1 byte)/42 (1 bit).</p> <p>The &lt;Scene number button scene 1&gt; and &lt;Scene number button scene 2&gt; parameters are displayed.</p> <p>Scene numbers can be assigned to the Scene 1 <math>\Rightarrow</math> 1 and Scene 2 <math>\Rightarrow</math> 2 buttons on theSenda B or theSenda S user remote control.</p> <p>Scene controls are not supported.</p>
Scene number user remote control button scene 1 Scene number user remote control button scene 2	<p>inactive</p> <p>Scene 1–64</p>	<p>The parameters are visible if the parameter &lt;Scene controls&gt; is set to "Send scene number on bus".</p> <p>No scene number is sent.</p> <p>The set scenario number is sent via object 42 (1 byte) by pressing the scene buttons on theSenda B or theSenda S user remote control.</p> <p>By holding the button (approx. 3 s) of the respective scene, the current scene will be saved.</p>
Define scenes with	<p>ETS</p> <p>Remote control</p>	<p>This parameter is visible if the parameter &lt;Scene controls&gt; is set to "Use internal scenes".</p> <p>The following parameters are displayed:</p> <ul style="list-style-type: none"> <li>- &lt;Output value user remote control scene 1, channel C1&gt;</li> <li>- &lt;Output value user remote control scene 2, channel C1&gt;</li> <li>- &lt;Output value user remote control scene 1, channel C2&gt;</li> <li>- &lt;Output value user remote control scene 2, channel C2&gt;</li> </ul> <p>The output values are fixed by the values configured in the ETS.</p> <p>The output values are stored with the user remote control. See theSenda B or theSenda S operating manual.</p>
User remote control output value, scene 1, channel C1 light	<p>Off, On</p> <p>Off, 1% – 100%, 30%</p>	<p>Value of scene 1, channel C1 in switching mode.</p> <p>Value of scene 1, channel C1 in constant lighting control.</p>
User remote control output value, scene 2, channel C1 light	<p>Off, On</p> <p>Off, 1% – 100%, 70%</p>	<p>Value of scene 2, channel C1 in switching mode.</p> <p>Value of scene 2, channel C1 in constant lighting control.</p>
User remote control output value, scene 1, channel C2 light	<p>Off, On</p> <p>Off, 1% – 100%, 30%</p>	<p>Value of scene 1, channel C2 in switching mode.</p> <p>Value of scene 1, channel C2 in constant lighting control.</p>
User remote control output value, scene 2, channel C2 light	<p>Off, On</p> <p>Off, 1% – 100%, 70%</p>	<p>Value of scene 2, channel C2 in switching mode.</p> <p>Value of scene 2, channel C2 in constant lighting control.</p>

### 2.4.18 Scene functions

The lighting channels of the presence detector can be blocked, or the response affected further, when receiving and matching with a scene number. The presence detector can be blocked in a defined manner:

- for a defined period of time
- until the presence detector is unblocked

Parameter name	Values	Meaning
Scene function 1	inactive  Block lighting channels  Unblock lighting channels  Use internal scene 1/2 output values  Deactivate control  Activate control	The behaviour of the presence detector can be controlled with 8 different scene functions.
Scene function 2		No scene number that blocks the presence detector is defined.
Scene function 3		Blocking of lighting channels C1/C2
Scene function 4		Push button operation is still possible.
Scene function 5		Unblocking lighting channels C1/C2
Scene function 6		Use additional selection of internal scenes.
Scene function 7		Control is stopped, object 2/13 no longer transmits telegrams. An OFF telegram is sent via object 0/11 after the time delay has expired.
Scene function 8		The constant lighting control is activated. The presence detector controls the lighting depending on brightness.
Scene number	1 .. 64	
Validity of block	1 h – 9 h  Until unblocking	Lighting channels remain disabled during the set time. Manual unblocking of the lighting channels is possible any time: <ul style="list-style-type: none"> <li>- Reception of corresponding scene number on bus object 30</li> <li>- Unblock command on bus object 28.</li> </ul>

### 3. Manual operation with push buttons

The presence detector can be overridden by using push buttons or other overriding commands. It is important to know that no separate push button input objects are required for this. On the contrary, the presence detector responds to telegrams sent directly to the actuators by the push buttons or superior functions. For this purpose, the same group address is used for the push button output, the detector output, and the actuator input.

Manual operation applies exclusively to the light outputs. The presence and brightness outputs are not affected by manual operation.

#### 3.1 Manual operation via switching function without dimmable lighting

If the lighting is operated manually via <Function channel C1/C2 light> "Switch lights", the presence detector responds as follows:

Push button operation	Response of lighting/presence detector
ON telegram	The lighting is switched on with an ON telegram to object 0/11. The lighting remains switched on for 30 minutes if the room is occupied. Light measurement is deactivated. The light measurement is reactivated after the 30 minutes. An OFF telegram is sent in case of sufficient brightness. If the room is vacated before the 30 minutes have expired, the light will be switched off normally after the completion of the set time delay.
OFF telegram	The lighting is switched off with an OFF telegram to object 0/11. The lighting remains switched off while the room is occupied. The detector returns to the normal switching mode after the room is vacated and the time delay has expired.



### 3.2 Manual operation via switching function with dimmable lighting

If the lighting is operated manually via the <Function channel C1/C2 light> "Switch lights" and <Lighting dimmable in the switching mode> "yes", the presence detector responds as follows:

Push button operation	Response of lighting/presence detector
ON telegram	The lighting is switched on with an ON telegram to object 0/11. The lighting remains switched on for 30 minutes if the room is occupied. Light measurement is deactivated. The light measurement is reactivated after the 30 minutes. An OFF telegram is sent in case of sufficient brightness. If the room is vacated before the 30 minutes have expired, the light will be switched off normally after the completion of the set time delay.
Dimming telegram (4 bit)	The lighting is dimmed with a dimming telegram to object 1/12. The lighting remains at the set dimming value for the configured time <Duration of manual override>.
Value telegram (1 byte)	The lighting is dimmed with a value telegram to object 2/13. The lighting remains at the transmitted value while the room is occupied. The detector returns to the normal switching mode after the room is vacated and the time delay has expired.
OFF telegram	The lighting is switched off with an OFF telegram to object 0/11. The lighting remains switched off while the room is occupied. The detector returns to the normal switching mode after the room is vacated and the time delay has expired.

### 3.3 Manual operation with constant lighting control function

If the lighting is operated manually via <Function channel C1/C2 light> "Constant lighting control", the presence detector responds as follows:

Push button operation	Response of lighting/presence detector
ON telegram	The lighting is switched on with an ON telegram to object 0/11. The constant lighting control is activated. The presence detector controls the lighting depending on brightness.
Dimming telegram (4 bit)	The lighting is dimmed with a dimming telegram to object 1/12. school: Constant lighting control is temporarily interrupted by manual dimming. The setpoint remains unchanged. office: Constant lighting control remains active temporarily after manual dimming to the current brightness value as the new setpoint value. After the time delay has expired, the originally configured set point value is restored.
Value telegram (1 byte)	The lighting is dimmed with a value telegram to object 2/13. The lighting remains at the transmitted value while the room is occupied. The detector returns to normal standard operating mode after the room is vacated and after expiry of the time delay.
OFF telegram	The lighting is switched off with an OFF telegram to object 0/11. The lighting remains switched off while the room is occupied. The detector returns to normal standard operating mode after the room is vacated and after expiry of the time delay.

### 3.4 Manual operation with constant lighting control function without depending on presence

If the lighting is operated manually via <Function channel C1/C2 light> "Constant lighting control without depending on presence", the presence detector responds as follows:

Push button operation	Response of lighting/presence detector
ON telegram	The lighting is switched on with an ON telegram to object 0/11. The constant lighting control is activated. The presence detector controls the lighting depending on brightness.
Dimming telegram (4 bit)	The lighting is dimmed with a dimming telegram to object 1/12. school: Constant lighting control is interrupted by manual dimming until the controller is activated again via object 24 or 30. The setpoint remains unchanged. office: Constant lighting control remains active after manual dimming to the new setpoint value. When deactivating the controller via object 24 or 30, the originally configured setpoint value will be restored
Value telegram (1 byte)	The lighting is dimmed with a value telegram to object 2/13. The lighting remains at the transmitted value until control is activated via object 24 or 30.
OFF telegram	The lighting is switched off with an OFF telegram to object 0/11. The lighting remains off until control is activated via object 24 or 30.

#### 4. Parallel switching

In larger corridors, several detectors can be connected in parallel. This extends the overall presence detection area.

##### 4.1 Master/Slave parallel switching

A "Master in parallel switching" can be connected to several "Slaves". For this, the trigger inputs/outputs are connected with each other. The Slaves only supply presence information from their detection area. The Master performs the brightness measurement and the administration of all parameter settings.

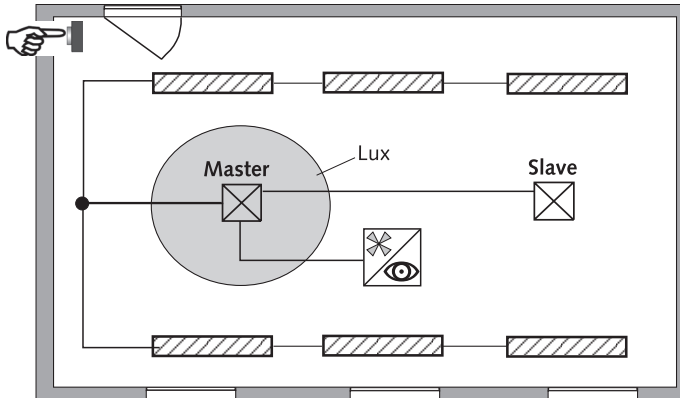

##### 4.2 Master/Master parallel switching

Several "Masters in parallel switching" can be linked with each other. Presence detection is completed jointly, while light measurement, parameter settings and lighting control are individually processed by each Master. This results in several light outputs with their own light measurement but with joint presence detection.

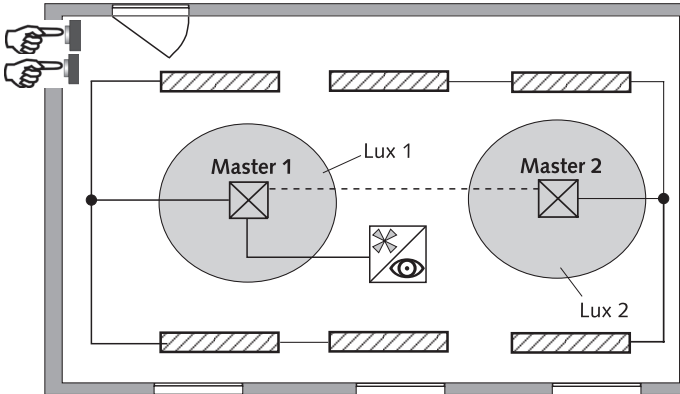

##### 4.3 Telegram load when using parallel switching

With parallel switching, each Master in parallel switching and each Slave sends a maximum of two telegrams per minute, provided there is somebody in the detection area. The interval between two telegrams can be increased to 4 minutes to reduce the telegram load. Please note that the time delay can never be shorter than the interval between two telegrams, in order to prevent unintentional switch off.

Parallel switching is compatible with all ThebenHTS KNX presence detectors.

### 5. Aura effect function

With the aura effect function, the light follows the users based on the area they are in. The surrounding areas are dimmed up to a set orientation light value. This guarantees better orientation and greater safety. If the person in the room moves, the light accompanies this person like an aura.

You can find further information and a video about the aura effect at the following link:

<https://www.theben.de/de/thepassa-p360-knx-up-wh-2019300>

Example - warehouse:

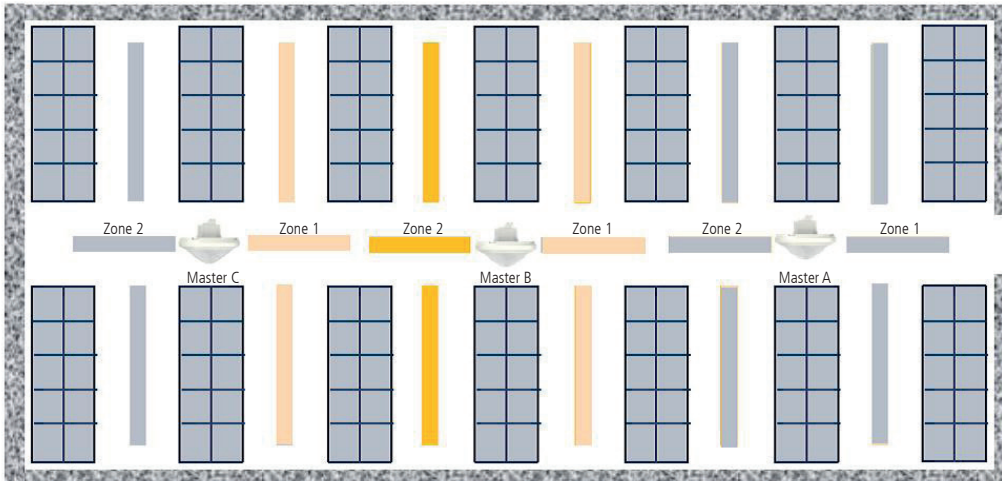

Each detector has set the detection zone to zone 1 and zone 2 separately. Trigger objects "channel C1 light aura effect" and "channel C2 light aura effect" are available. They can be linked up to adjacent zones. As soon as an aura signal is received and no motion was detected in the zone, the lighting channels in these zones will go to the set aura dimming value.

An example of the aura effect with the required object links and parameter settings can be found on page 67, chapter 11.1.10.

## 6. Brightness setpoint value/constant lighting control

### 6.1 Setting the brightness setpoint value

The brightness setpoint value defines the minimum required brightness. The currently prevailing brightness is measured underneath the presence detector. If the prevailing brightness is below the setpoint, the light is switched on if a presence is detected.

The room correction factor is a measurement for the difference between the brightness measurement at the ceiling and on the work area.

The brightness measurement value at the ceiling is influenced by the installation location, incidence of light, position of the sun, weather conditions, the reflection properties of the room, and the furniture.

The room correction factor allows the brightness measurement taken by the presence detector to be adapted to the conditions in the room. In this way, the brightness value measured by the presence detector can be scaled to the lux meter value ④ measured on the surface below the presence detector.

See <Room correction factor> parameter on page 19.

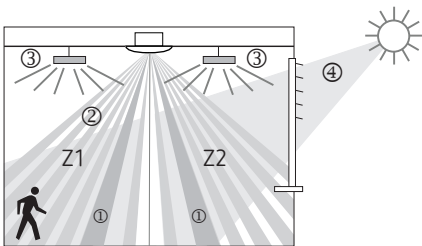

$$\text{Room correction factor} = \frac{\text{Brightness value at the ceiling}}{\text{Brightness value on the work surface}}$$

### 6.2 Calibration of brightness measurement

The presence detector measures artificial light and daylight by means of two directed light measurements. Light measurement Z1 measures the brightness in zone 1. In zone 2, light measurement Z2 measures the brightness. The alignment of both brightness measurements has to be taken into account during installation. Each light measurement zone maps a rectangle of about 2 x 4 m on the floor. Depending on the selected the detection zone, the light measurements are assigned as follows:

Selection of detection zone	Lighting channel	Light measuring zone
only zone 1	Channel C1 - light	Zone 1
only zone 2	Channel C2 - light	Zone 2
Zone 1 + zone 2 together	Channel C1 - light	∅ from zone 1 + zone 2
Zone 1 / zone 2 separately	Channel C1 - light / channel C2 - light	Zone 1 / zone 2

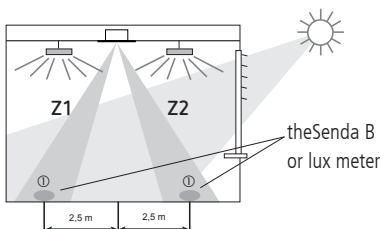

#### Remote control theSenda B and the theSenda Plug app:

1. Connect "theSenda B" remote control with the corresponding "theSenda Plug" app.
2. Select the appropriate detector type and load the parameter set.
3. Select the <Brightness measurement value C 1> parameter.
4. Using theSenda B remote control:
  - Set up the theSenda B according to the drawing, and move a few steps away from the measurement location, so the lux measurement will not be influenced.
  - Then press "OK".

- A new window with measured brightness measurement value is shown. If you would like to apply this value, press "OK".
- 5. With lux meter:
  - Set up or align the lux meter according to the drawing, and read the lux value.
  - Then press "Enter" on the app.
  - A new window opens. Enter the lux value and press "OK".

The brightness measurement value appears in the display. -Then press the send button "☒". After this, the brightness measurement is calibrated.

The room correction factor is calculated from this automatically. Values between 0.05 and 2.0 are permitted. Calculated values outside the permitted range will automatically be set to the appropriate limit value.

The calculated room correction factor will be applied immediately. For monitoring purposes, the room correction factor can be queried via the object 8 (C1) / 19 (C2) (scale factor 100).
- 6. For calibration of light measuring zone 2, select <Brightness measurement value C2> parameter and repeat the entire process.

Using "SendoPro 868-A" remote control:

1. Set up or align the lux meter according to the drawing, and read the lux value.
  2. Select the <Brightness measurement value C1> parameter on the SendoPro with the "OK" button.
  3. Select the lux value and press "OK".
  4. Then press the send button "☒". After this, the brightness measurement is calibrated.
- The room correction factor is calculated from this automatically. Values between 0.05 and 2.0 are permitted. Calculated values outside the permitted range will automatically be set to the appropriate limit value.
- The calculated room correction factor will be applied immediately. For monitoring purposes, the room correction factor can be queried via the object 8 (C1) / 19 (C2) (scale factor 100).
5. For calibration of light measuring zone 2, select <Brightness measurement value C2> parameter and repeat the entire process.

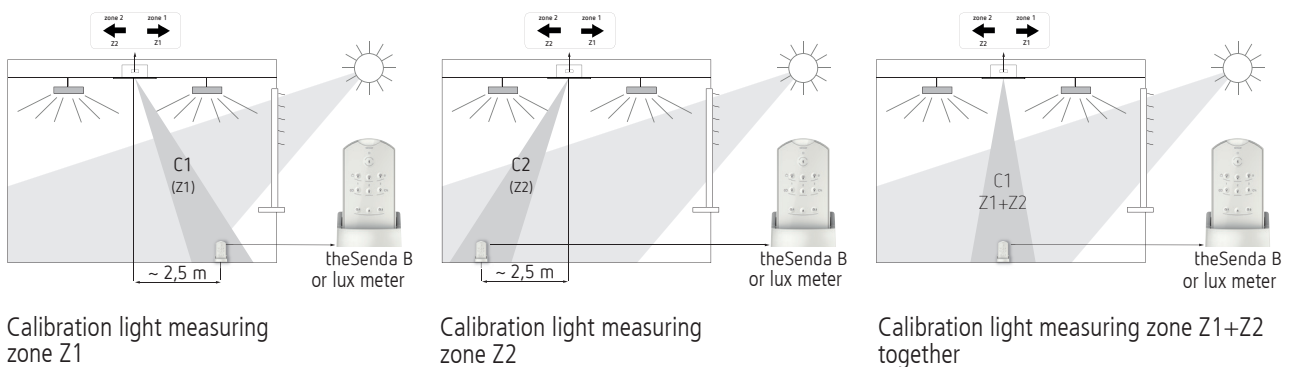

As an alternative, calibration of brightness measurement can also be carried out via the ETS. Prerequisite is that the <Set brightness measurement value via bus> parameter has been set to "yes". The measured lux value is transmitted to the presence detector via objects 7/18 (brightness measurement value C1 and/or brightness measurement value C2).

The room correction factor is calculated from this automatically. Values between 0.05 and 2.0 are permitted. Calculated values outside the permitted range will automatically be set to the appropriate limit value.

The calculated room correction factor will be applied immediately. For monitoring purposes, the room correction factor can be queried via the object 8/19 (scale factor 100).



The standard value of the room correction factor is 0.3 and is suitable for most applications.  
The sensitivity of the light sensor to changes in brightness is affected by the change in the room correction factor.

### 6.3 Configuration of switching/dimming actuators and DALI gateways for constant lighting control

#### 6.3.1 Recommended configuration

The following configuration of the actuators is recommended for the optimum functioning of constant lighting control:

Time for running through dimming range (0%-100%)	10 seconds
Jump to or dim to dimming values	soft on
Immediately apply dimming values	immediately
Can be switched off by dimming	No
Can be switched on by dimming	Yes
Lower dimming limit	Minimum
Upper dimming limit	Maximum
Switch off behaviour: Switch off or dim until off	Switch off
Brightness value at switch on (optional)	as required, approx. 50%
Send status value of the dimming value	only via read request

Note: The parameter designations can vary according to the model of the dimming actuator, switching/dimming actuators, or DALI gateway. The actuator does not need to generate automatic status reports. The detector acquires this information itself.

#### 6.3.2 Actuators with separate object for status feedback (value)

Numerous actuators and gateways have a separate object for status feedback (1 byte value), for example:

- Theben DMG 2 T / DME 2 T universal dimming actuator
- Theben SMG 2 S / SME 2 S control device for dimmable electronic ballasts

They are connected to the thePassa P360 KNX as follows to ensure perfect constant lighting control:

Actuator group addresses				C	R	W	T	Act.
0	On/Off	↔	10/0/1	√		√	Leave default	
1	Dimming	↔	10/0/2	√		√		
2	Set value	↔	10/0/3	√		√		
10	Status (value)	⇒	10/0/7	√	√			

thePassa P360 KNX group addresses			
0	Switching	⇒	10/0/1
1	Brighter/darker	⇒	10/0/2
2	Send value	⇒	10/0/3
3	Feedback value	↔	10/0/7

#### 6.3.3 Actuators without separate object for status feedback (value)

Some actuators do not have a separate object for status feedback. They are connected to the thePassa P360 KNX as follows to ensure perfect constant lighting control:

Actuator group addresses				C	R	W	T	Act.
x	On/Off	↔	10/0/1		√		√	Leave default
x	Dimming	↔	10/0/2		√		√	
x	Set value	↔ ⇒ *)	10/0/7 *)	10/0/3	√	√ **)	√	

thePassa P360 KNX group addresses			
0	Switching	⇒	10/0/1
1	Brighter/darker	⇒	10/0/2
2	Send value	⇒	10/0/3
3	Feedback value	↔	10/0/7

\*) set to sending!

\*\*\*) The read flag has to be set manually on some actuators

x) Object in accordance with used product

Note: If a number of actuators are connected to one light output of the detector, it is necessary to ensure identical configuration of the actuators. Exception: The read flag may be set on only one of the actuators per lighting group.

## 7. Test modes

The thePassa P360 KNX has two test modes.

- Presence test, page 40 Kapitel 7.1
- Light test, page 40 Kapitel 7.2

### 7.1 Presence test

The presence test serves to test presence detection and parallel switching.

<b>Activate</b>	<ul style="list-style-type: none"> <li>- Control command presence test "ON" with "theSenda Plug" app, "On" with management remote control "SendoPro 868-A", or installation remote control "theSenda P" button </li> <li>- ON telegram via bus object 51</li> </ul> <p>The presence test mode can be activated anytime.</p>
<b>End</b>	<p>With subsequent restart:</p> <ul style="list-style-type: none"> <li>- Control command presence test "Off" with "theSenda Plug" app, or "Off" with management remote control "SendoPro 868-A"</li> <li>- OFF telegram via bus object 51</li> <li>- Mains failure and thus power up</li> <li>- Automatically according to the time set in the ETS, parameter &lt;Activation of test mode&gt;</li> <li>- Control command "Restart" (theSenda Plug app, or SendoPro 868-A)</li> <li>- Reset with theSenda P button </li> </ul> <p>Without restart:</p> <ul style="list-style-type: none"> <li>- Activation of light test with the "SendoPro 868-A" management remote control</li> </ul>

LED display Status of channels	Description
On	When movement occurs, the LED goes on and channels C1, C2 switch on.
OFF	After the movement stops, the LED is off and channels C1, C2 switch off after approx. 10 s.

#### Test response

- Deactivated brightness measurement, light output does not react to brightness.
- The detector reacts as in configuration type fully automatic device, even if semi-automatic is set.
- The control type changes to switching if the control type is set to constant lighting control. The light is not controlled.
- Light "On" during motion; light "Off" during absence
- Channels C1 and C2 light have a fixed time delay of 10 s.
- The response of channels C4, C5 presence remains unchanged as in normal operating mode.

#### Commands and adjustable parameters

In presence test mode, the following commands are possible with "theSenda Plug" app, or «SendoPro 868-A» management remote control:

- End presence test
- Activating the light test
- Changing detection sensitivity

The selected detection sensitivity (1 . . 5) is unchanged on activation of the presence test. The sensitivity can be adjusted during the test, and will remain unchanged after a restart.

The presence detector performs a restart after the end of the test mode.

### 7.2 Light test

The "light test" test mode is used to monitor the brightness setpoint level (brightness threshold).

<b>Activate</b>	<ul style="list-style-type: none"> <li>- Control command light test "ON" with "theSenda Plug" app, or "On" with management remote control "SendoPro 868-A"</li> <li>- ON telegram via bus object 52</li> </ul> <p>The light test mode can be activated anytime.</p>
<b>End</b>	<p>With subsequent restart:</p> <ul style="list-style-type: none"> <li>- Control command light test "OFF" with "theSenda Plug" app, or "Off" with management remote control "SendoPro 868-A"</li> <li>- OFF telegram via bus object 52</li> <li>- Mains failure and thus power up</li> <li>- Automatically according to the time set in the ETS, parameter &lt;Activation of test mode&gt;</li> <li>- Control command "Restart" ("theSenda Plug" app, or "SendoPro 868-A")</li> <li>- Reset with theSenda P button </li> </ul> <p>Without restart:</p> <ul style="list-style-type: none"> <li>- Activation of presence test with "theSenda Plug" app, or "SendoPro 868-A" management remote control</li> </ul>



LED display	Description
Flashing, 5 s Off/0.3 s On	The LED flashes as long as the light test is active.

**Test response**

The presence detector responds 100% as in normal operating mode, only the reaction to bright/dark is faster. This makes it possible to test the brightness threshold and the adaptive response.

All selected functions and parameters remain unchanged

**Commands and adjustable parameters**

In light test mode, the following commands are possible with "theSenda Plug" app, or «SendoPro 868-A» management remote control:

- End light test
- Change lighting channel C1/C2 brightness setpoint value
- Activate presence test
- Brightness measurement value C1/C2

The presence detector performs a reset after the end of the test mode.

Do not use a torch to switch the presence detector. The presence detector will teach in this and thereby distort the adaptive light thresholds and hysteresis values.  
In order to simulate this response, the area below the presence detector should be illuminated or the blinds be operated. Reactivate the light test for a new test.

**8. User remote control theSenda S**

See also theSenda S operating manual.

**8.1 Performance characteristics of theSenda S**

theSenda S user remote control makes it easy to switch and dim lighting using thePassa P360 KNX presence detector. theSenda S has two channels for controlling lighting groups, blinds or external channels with switching and dimming. theSenda S also provides the option of saving two different lighting scenarios which can be retrieved anytime at the touch of a button.

**8.2 Combining the presence detector and theSenda S**

The presence detector channels and the theSenda S channels are linked via an IR group address. 2 IR group addresses are available for linking.

Operation of a lighting group requires that the presence detector channel IR group address and that of theSenda S channel match.

The selection of the IR group addresses enables the separation of neighbouring detectors controlled by the theSenda S user remote control. IR group addresses I and II are allocated permanently to 4 buttons on theSenda S user remote control, and cannot be changed. Further information can be found in the operating instructions of theSenda S.

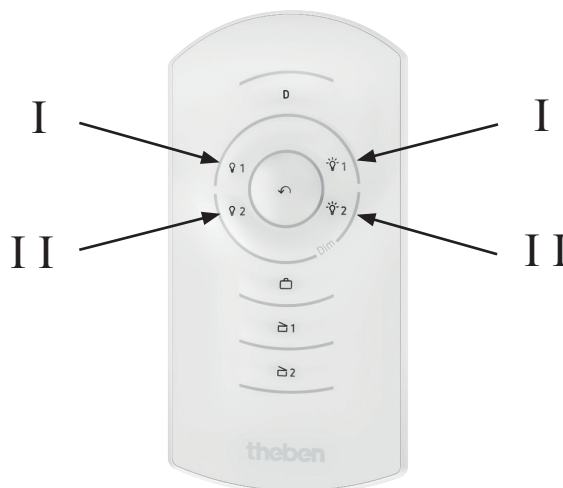

8.3 Examples of set IR group addresses

Subject	Chapter/page
One presence detector, two lighting channels	8.3.1 page 42
Two presence detectors, each with one lighting channel and blinds	8.3.2 page 43
Two presence detectors, two lighting channels	8.3.3 page 44
Two presence detectors with one and two internal lighting channels	8.3.4 page 45

8.3.1 One presence detector, two lighting channels

Description	Using a theSenda S user remote control, two lighting channels are controlled manually by one presence detector. Channel C1 light of the presence detector is controlled by channel 1 of theSenda S. Channel C2 light of the presence detector is controlled by channel 2 of theSenda S.
-------------	---

Devices	thePassa P360 KNX (Order No. 2019300) theSenda S (Order No. 9070911)
---------	---

Overview		<table border="1"> <thead> <tr> <th>Master</th> <th>Channel</th> <th>IR Grp. Addr.</th> </tr> </thead> <tbody> <tr> <td></td> <td>Channel C1 light</td> <td>I</td> </tr> <tr> <td></td> <td>Channel C2 light</td> <td>II</td> </tr> </tbody> </table>	Master	Channel	IR Grp. Addr.		Channel C1 light	I		Channel C2 light	II
Master	Channel	IR Grp. Addr.									
	Channel C1 light	I									
	Channel C2 light	II									



Parameter	thePassa P360 KNX		
	Master		
	Parameter page	Parameter	Setting
	Remote control	Channel C1 light	I
		Channel C2 light	II



8.3.2 Two presence detectors, each with one lighting channel and blinds

Description	<p>One lighting channel on each of two presence detectors as well as the blinds channel on one presence detector are controlled manually by a theSenda S user remote control.</p> <p>The respective channels C1 light on the two presence detectors are controlled by channel 1 of theSenda S. As both lighting channels are controlled by the same IR group address, a mutual interaction between the lighting channels is possible. The user remote control must be aimed directly at the appropriate presence detector. Furthermore, the IR signals can be diverted in the room and therefore received by the other presence detector.</p> <p>The blinds are controlled by the Master 2 presence detector via channel 2 of theSenda S. Channel 2 commands are ignored by Master 1.</p>
-------------	---

Devices	<p>thePassa P360 KNX (Order No. 2019300)</p> <p>theSenda S (Order No. 9070911)</p>
---------	--

Overview	IR Grp. Addr.	Channel	Master 1	Master 2	Channel	IR Grp. Addr.
	I	Channel C1 light			Channel C1 light External blinds 2	I II
						

Parameter	thePassa P360 KNX Master 1		
	Parameter page	Parameter	Setting
	Remote control	Channel C1 light	I
	thePassa P360 KNX Master 2		
	Parameter page	Parameter	Setting
	Remote control	Channel C1 light	I
		External blinds 2	II

8.3.3 Two presence detectors, two lighting channels

Description	One lighting channel each on two presence detectors is controlled manually by a theSenda S user remote control. Lighting channel C1 on the Master 1 presence detector is controlled by channel 1 of theSenda S. Lighting channel C2 on the Master 1 presence detector is controlled by channel 2 of theSenda S. The lighting channels on the presence detectors are not influenced mutually by theSenda S commands.
-------------	---

Devices	thePassa P360 KNX (Order No. 2019300) theSenda S (Order No. 9070911)
---------	---

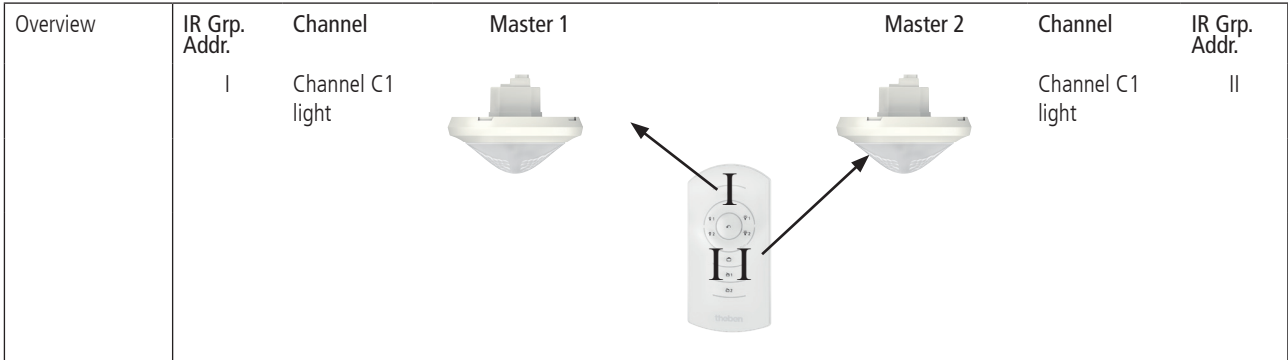

Parameter	thePassa P360 KNX Master 1		
	Parameter page	Parameter	Setting
	Remote control	Channel C1 light	I
	thePassa P360 KNX Master 2		
	Parameter page	Parameter	Setting
Remote control	Channel C1 light	II	

8.3.4 Two presence detectors with one and two internal lighting channels

Description	The lighting channels of two presence detectors are influenced separately by two theSenda S user remote controls. Channel C1 light of Master 1 presence detector is controlled by channel 1 of theSenda S 1. Channel C1 light of Master 2 presence detector is controlled by channel 1 of theSenda S 2. Channel C2 light of Master 2 presence detector is controlled by channel 2 of theSenda S 2.
-------------	--

Devices	thePassa P360 KNX (Order No. 2019300) theSenda S (Order No. 9070911)
---------	---

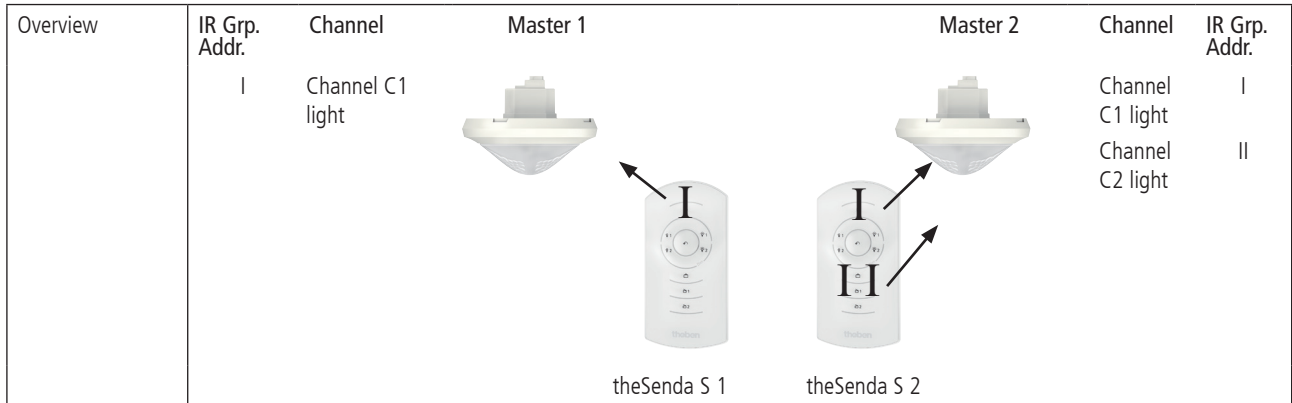

Parameter	thePassa P360 KNX Master 1		
	Parameter page	Parameter	Setting
	Remote control	Channel C1 light	I
	thePassa P360 KNX Master 2		
	Parameter page	Parameter	Setting
	Remote control	Channel C1 light	I
		Channel C2 light	II

## 9. theSenda B user remote control

See also theSenda B operating manual.

### 9.1 Performance characteristics of theSenda B

theSenda B user remote control makes it easy to switch and dim lighting using thePassa P360 KNX presence detector. theSenda B has three channels for controlling lighting groups, blinds or external channels with switching and dimming. theSenda B also provides the option of saving two different lighting scenarios which can be retrieved anytime at the touch of a button.

Together with theSenda B remote control and theSenda Plug app, many Theben presence and motion detectors, as well as theLeda D LED spotlights, can be configured and operated quickly, easily and safely. All remotely controllable presence and motion detectors from Theben come pre-installed. New and revised detector types are updated automatically, ensuring that you always have the latest versions. In this way, you will always be up-to-date.

#### Flexible detector search and configuration

The automatic search takes the installer directly to the corresponding detector. Alternatively, the filter function can be used. What's more, it is possible to search for detectors based on stored parameter sets. All detectors can be programmed with just a few clicks via the intuitive user interface. Comprehensive graphic and text-based help functions as well as animations provide assistance with configuration. Particularly in the case of detectors with an especially large range of functions, such as the DALI presence detectors, theSenda Plug makes configuration much easier and faster.

Parameter sets can be saved and named in a customer-specific way. This makes them easier to reuse, for example in different buildings. The parameter sets can also be created with theSenda Plug in advance, and transferred later, during start-up. For archiving and administration purposes, the parameter sets can be exported, for instance via email.

#### Perfect functional interaction with theSenda B remote control

While the detectors are configured via the theSenda Plug app, the programmed data is transmitted to the respective detector via the theSenda B remote control and infrared. Communication between app and remote control is via Bluetooth. The highlight is the fact that theSenda B offers a built-in lux meter which can be used to calibrate the light measurement simply and conveniently. The measured lux values are then transmitted back to theSenda Plug via Bluetooth. The supplied wall and table mount ensures that the remote control is always to hand.



### 9.2 Combining the presence detector and theSenda B

The presence detector channels and the theSenda B channels are linked via an IR group address. 8 IR group addresses are available for linking. Operation of a lighting group requires that the presence detector channel IR group address and that of theSenda B channel match.

The selection of the IR group addresses enables the separation of neighbouring detectors controlled by the theSenda B user remote control. The IR group addresses on theSenda B user remote control can flexibly be allocated to channels 1 to 3 and scenes 1 + 2. The setting can easily be made via "theSenda Plug", menu "theSenda B". IR group addresses I to VIII are available for selection. It is also possible to allocate several IR group addresses to the channels and scenes. The user remote control theSenda B is delivered with the following factory settings:

- Channel 1 light: IR group address I
- Channel 2 light: IR group address II
- Channel 3 light: IR group address III
- Scene 1: IR group address I, II and III
- Scene 2: IR group address I, II and III

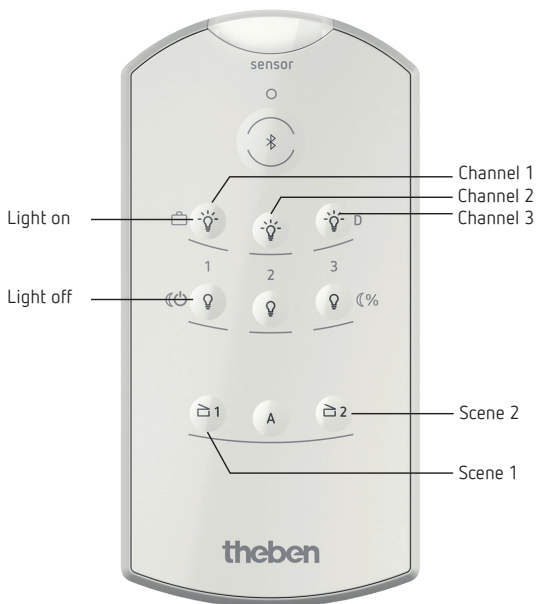

9.3 Examples of set IR group addresses

Subject	Chapter/page
One presence detector, two lighting channels	9.3.1 page 48
Two presence detectors, each with one lighting channel and blinds	9.3.2 page 49
Two presence detectors, two lighting channels	9.3.3 page 50
Two presence detectors with one and two internal lighting channels	9.3.4 page 50
Two presence detectors, two lighting channels and blinds	9.3.5 page 51

9.3.1 One presence detector, two lighting channels

Description	Using a theSenda B user remote control, two lighting channels are controlled manually by one presence detector. Channel C1 light of the presence detector is controlled by channel 1 of theSenda B. Channel C2 light of the presence detector is controlled by channel 2 of theSenda B.
-------------	---

Devices	thePassa P360 KNX (Order No. 2019300) theSenda B (Order No. 9070985)
---------	---

Overview	<table border="1" style="margin-left: 200px;"> <thead> <tr> <th>Master</th> <th>Channel</th> <th>IR Grp. Addr.</th> </tr> </thead> <tbody> <tr> <td></td> <td>Channel C1 light</td> <td>I</td> </tr> <tr> <td></td> <td>Channel C2 light</td> <td>II</td> </tr> </tbody> </table>	Master	Channel	IR Grp. Addr.		Channel C1 light	I		Channel C2 light	II
Master	Channel	IR Grp. Addr.								
	Channel C1 light	I								
	Channel C2 light	II								

Parameter	thePassa P360 KNX		
	Master		
	Parameter page	Parameter	Setting
	Remote control	Channel C1 light	I
Channel C2 light		II	



9.3.2 Two presence detectors, each with one lighting channel and blinds

Description	<p>One lighting channel on each of two presence detectors as well as the blinds channel on one presence detector are controlled manually by a theSenda B user remote control.</p> <p>The respective channels C1 light on the two presence detectors are controlled by channel 1 of theSenda B. As both lighting channels are controlled by the same IR group address, a mutual interaction between the lighting channels is possible. The user remote control must be aimed directly at the appropriate presence detector. Furthermore, the IR signals can be diverted in the room and therefore received by the other presence detector.</p> <p>The blinds are controlled by the Master 2 presence detector via channel 2 of theSenda B. Channel 2 commands are ignored by Master 1.</p>
-------------	---

Devices	<p>thePassa P360 KNX (Order No. 2019300)</p> <p>theSenda B (Order No. 9070985)</p>
---------	--

Overview	IR Grp. Addr.	Channel	Master 1	Master 2	Channel	IR Grp. Addr.
	I	Channel C1 light			Channel C1 light External blinds 2	I II

Parameter	thePassa P360 KNX Master 1		
	Parameter page	Parameter	Setting
	Remote control	Channel C1 light	I
	thePassa P360 KNX Master 2		
	Parameter page	Parameter	Setting
Remote control	Channel C1 light	I	
	External blinds 2	II	

9.3.3 Two presence detectors, two lighting channels

Description	One lighting channel each on two presence detectors is controlled manually by a theSenda B user remote control. Lighting channel C1 on the Master 1 presence detector is controlled by channel 1 of theSenda B. Lighting channel C2 on the Master 1 presence detector is controlled by channel 2 of theSenda B. The lighting channels on the presence detectors are not influenced mutually by theSenda S commands.
-------------	---

Devices	thePassa P360 KNX (Order No. 2019300) theSenda B (Order No. 9070985)
---------	---

Overview	IR Grp. Addr.	Channel	Master 1	Master 2	Channel	IR Grp. Addr.
	I	Channel C1 light			Channel C1 light	II

Parameter	thePassa P360 KNX Master 1		
	Parameter page	Parameter	Setting
	Remote control	Channel C1 light	I
	thePassa P360 KNX Master 2		
	Parameter page	Parameter	Setting
	Remote control	Channel C1 light	II

9.3.4 Two presence detectors with one and two internal lighting channels

Description	The lighting channels of two presence detectors are influenced separately by two theSenda B user remote controls. Channel C1 light of Master 1 presence detector is controlled by channel 1 of theSenda B 1. Channel C1 light of Master 2 presence detector is controlled by channel 1 of theSenda B 2. Channel C2 light of Master 2 presence detector is controlled by channel 2 of theSenda B 2.
-------------	--

Devices	thePassa P360 KNX (Order No. 2019300) theSenda B (Order No. 9070985)
---------	---

Overview	IR Grp. Addr.	Channel	Master 1	Master 2	Channel	IR Grp. Addr.
	I	Channel C1 light			Channel C1 light Channel C2 light	I II
			theSenda B 1	theSenda B 2		

Parameter	thePassa P360 KNX Master 1		
	Parameter page	Parameter	Setting
	Remote control	Channel C1 light	I
Parameter	thePassa P360 KNX Master 2		
	Parameter page	Parameter	Setting
	Remote control	Channel C1 light	I
		Channel C2 light	II

### 9.3.5 Two presence detectors, two lighting channels and blinds

Description	<p>One lighting channel on each of two presence detectors as well as the blinds channel on one presence detector are controlled manually by the theSenda B user remote control.</p> <p>Lighting channel C1 on the Master 1 presence detector is controlled by channel 1 of theSenda B.</p> <p>Lighting channel C2 on the Master 1 presence detector is controlled by channel 2 of theSenda B.</p> <p>The blinds are controlled by the Master 2 presence detector via channel 3 of theSenda B.</p> <p>The lighting channels of the presence detectors and the blinds are not influenced mutually by theSenda B.</p>
-------------	--

Devices	<p>thePassa P360 KNX (Order No. 2019300)</p> <p>theSenda B (Order No. 9070985)</p>
---------	--

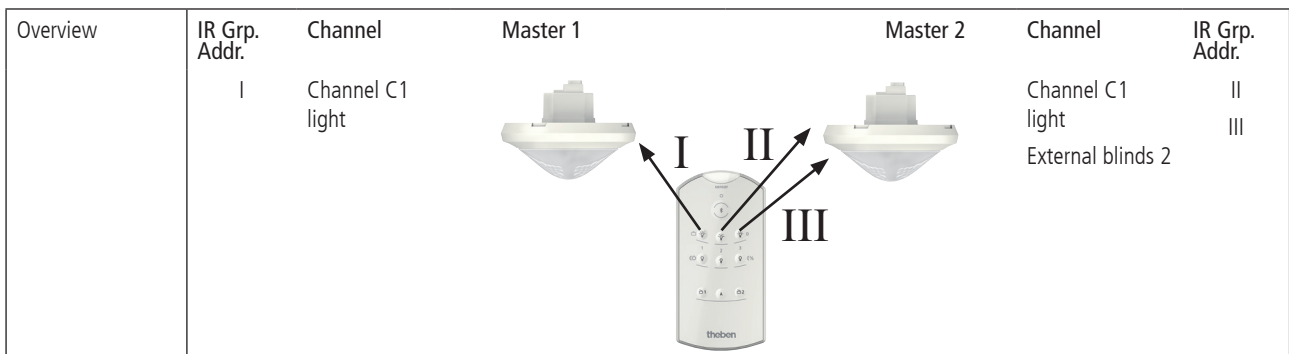

Parameter	thePassa P360 KNX Master 1		
	Parameter page	Parameter	Setting
	Remote control	Channel C1 light	I
Parameter	thePassa P360 KNX Master 2		
	Parameter page	Parameter	Setting
	Remote control	Channel C1 light	II
		External blinds 2	III

## 10. Troubleshooting

Fault/error	Cause
Light does not switch on or switches off during presence and darkness	Lux value is set too low; detector set on semi-automatic; light was switched off manually via button or theSenda S; person not within detection area; obstruction(s) interrupting detection; time delay set too short
Light stays on with detection of presence despite sufficient brightness	Lux value is set too high; the light was just switched on manually via push button or remote control (wait 30 minutes); detector is in test mode
Light does not switch off, or light switches on spontaneously when no one is present	Wait for time delay (self-learning); thermal sources of interference in the detection area: fan heaters, incandescent lamps/halogen spotlights, moving objects (e.g. curtains hanging in an open window); the startup phase was not problem-free.
Error flashing (3x per second)	Error during start-up phase or during operation: - With the first download (factory setting) or after discharging the detector, valid parameter values have to be downloaded first, otherwise error flashing will be displayed. - Device not functional.

## 11. Appendix

### 11.1 Typical applications

Subject	Chapter/page
Presence and brightness-dependent switching of light	11.1.1 page 53
Presence and brightness-dependent switching of light, additional manual override via push button	11.1.2 page 54
Presence and brightness-dependent switching of light with two lighting groups in a room	11.1.3 page 55
Presence and brightness-dependent switching with additional heating control	11.1.4 page 57
Constant lighting control	11.1.5 page 59
Constant lighting control, additional manual override via push button	11.1.6 page 61
Constant lighting control with two lighting groups	11.1.7 page 63
Master/Slave parallel switching	11.1.8 page 65
Master/Master parallel switching	11.1.9 page 66
Aura effect	11.1.10 page 67

#### 11.1.1 Presence and brightness-dependent switching of light

Description	The classic function of a presence detector is switching lights on only if a room is occupied and there is insufficient natural daylight. The lighting is automatically switched off if the room is vacated or the amount of daylight increases.
-------------	--

Devices	thePassa P360 KNX (Order No. 2019300) RMG 8 S KNX (Order No. 4930220)
---------	--

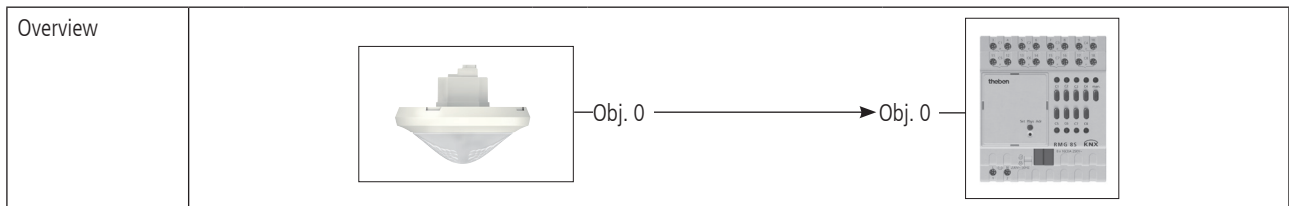

Links	thePassa P360 KNX		RMG 8 S		Comment
	No.	Object name / function	No.	Object name	
	0	Channel C1 light / switching	0	RMG 8 S channel C1	Switching lighting on and off

Parameter	thePassa P360 KNX		
	Parameter page	Parameter	Setting
	General	Operating mode	Master
		Detection zone	Zone 1 and Zone 2 together
		Master operating mode	Individual switching
		Function channel C1 light	Switching light..
	Channel C1 - light	Configuration type	Fully automatic device
		Brightness switching value	200 lx (e.g. for corridor application)
		Lighting time delay	5 min (as per customer specification)
	RMG 8 S		
	Parameter page	Parameter	Setting
	RMG 8 S channel C1: configuration options	Channel function	Switching on/off
	Standard or customer-defined parameter settings apply to unlisted parameters.		

11.1.2 Presence and brightness-dependent switching of light, additional manual override via push button

Description	<p>The presence detector switches the lighting. The lighting can also be switched on and off manually.</p> <p>When the light is switched on via push button, the user has 30 minutes of light if the room is occupied before the presence detector takes control again. When the light is switched off via a push button, the lighting remains switched off as long as the presence detector detects that the room is occupied. The presence detector takes control only after the time delay has elapsed.</p> <p>It is also possible to operate the presence detector in semi-automatic mode. In this case, the lighting must always be switched on by hand, the detector does not switch on the lighting automatically. The presence detector switches off the lighting as usual if there is sufficient daylight or if the room is unoccupied.</p>
-------------	--

Devices	<p>thePassa P360 KNX (Order No. 2019300)</p> <p>RMG 8 S KNX (Order No. 4930220)</p>
---------	---

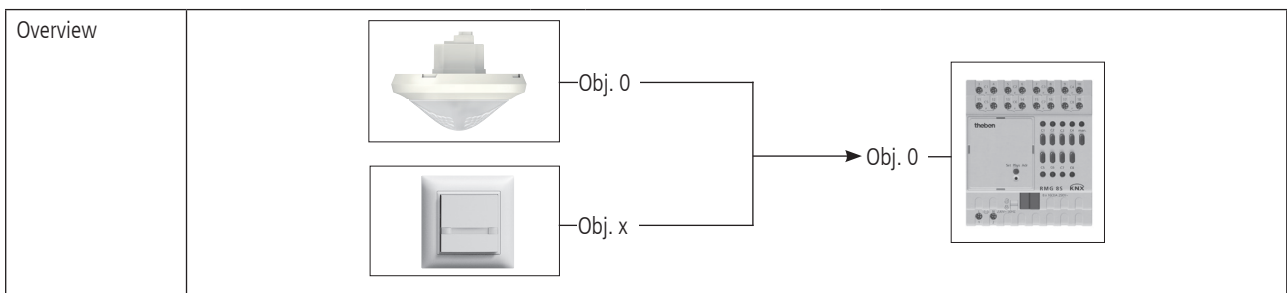

Links	thePassa P360 KNX		RMG 8 S		Comment
	No.	Object name / function	No.	Object name	
	0	Channel C1 light / switching	0	RMG 8 S channel C1	Switching lighting on and off
any KNX push button		RMG 8 S		Comment	
No.	Object name	No.	Object name		
	x	e.g. button 1	0	RMG 8 S channel C1	Manual switching on and off via push button

Parameter	thePassa P360 KNX		
	Parameter page	Parameter	Setting
	General	Operating mode	Master
		Detection zone	Zone 1 and Zone 2 together
		Master operating mode	Individual switching
		Function channel C1 light	Switching light..
	Channel C1 light	Configuration type	Fully automatic device / semi-automatic device
		Brightness switching value	200 lx (e.g. for corridor application)
		Lighting time delay	5 min (as per customer specification)
	KNX push button (example)		
	Parameter page	Parameter	Setting
	Rocker 1 left	Telegram on pressing the button	On
		Telegram when released	no telegram
	Rocker 1 right	Telegram on pressing the button	OFF
		Telegram when released	no telegram
	RMG 8 S		
	Parameter page	Parameter	Setting
	RMG 8 S channel C1: configuration options	Channel function	Switching on/off
	Standard or customer-defined parameter settings apply to unlisted parameters.		

### 11.1.3 Presence and brightness-dependent switching of light with two lighting groups in a room

Description	The presence detector switches two lighting groups, one near the window and the second in the interior of the room. The lighting group near the window is switched off by the presence detector before the one in the interior of the room due to the greater amount of daylight, making it possible to save energy.
-------------	--

Devices	thePassa P360 KNX (Order No. 2019300) RMG 8 S KNX (Order No. 4930220)
---------	--

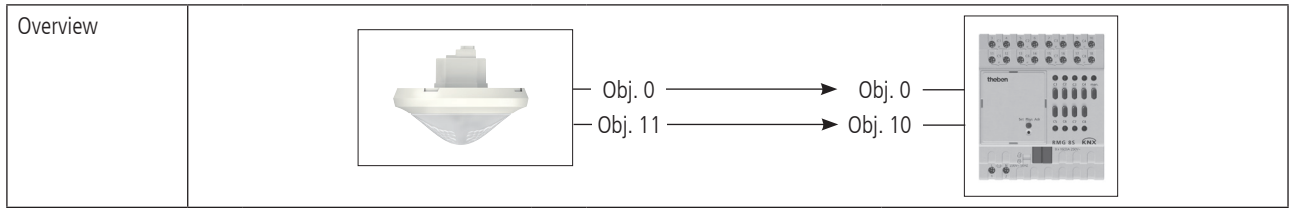

Links	thePassa P360 KNX		RMG 8 S		Comment
	No.	Object name / function	No.	Object name	
	0	Channel C1 light / switching	0	RMG 8 S channel C1	Switching lighting near the window on and off
	11	Channel C2 light / switching	10	RMG 8 S channel C2	Switching lighting in the interior of the room on and off

Parameter	thePassa P360 KNX		
	Parameter page	Parameter	Setting
General	Operating mode		Master
	Detection zone		Zone 1 and Zone 2 separately
	Master operating mode		Individual switching
	Function channel C1 light		Switching light..
	Function channel C2 light		Switching light..
Channel C1 - light	Configuration type		Fully automatic device
	Brightness switching value		200 lx (e.g. for corridor application)
	Lighting time delay		5 min (as per customer specification)
Channel C2 - light	Brightness switching value		200 lx (e.g. for corridor application)
<b>RMG 8 S</b>			
	Parameter page	Parameter	Setting
	RMG 8 S channel C1: configuration options	Channel function	Switching on/off
	RMG 8 S channel C2: configuration options	Channel function	Switching on/off
Standard or customer-defined parameter settings apply to unlisted parameters. Bear in mind the direction of the light measurement, see installation manual.			



11.1.4 Presence and brightness-dependent switching with additional heating control

Description	The presence output on the detector is also used for heating control in addition to the presence and daylight-dependent switching of one or two lighting groups. The output is configured with a switch-on delay. In large rooms, this switching can be extended with additional presence detectors (Master or Slave).
-------------	---

Devices	thePassa P360 KNX (Order No. 2019300) Mix combination: RMG 8 S + extension module HME 6 T (Order No. 4930220 + 4930245) RAMSES 713 S KNX (Order No. 7139201)
---------	--

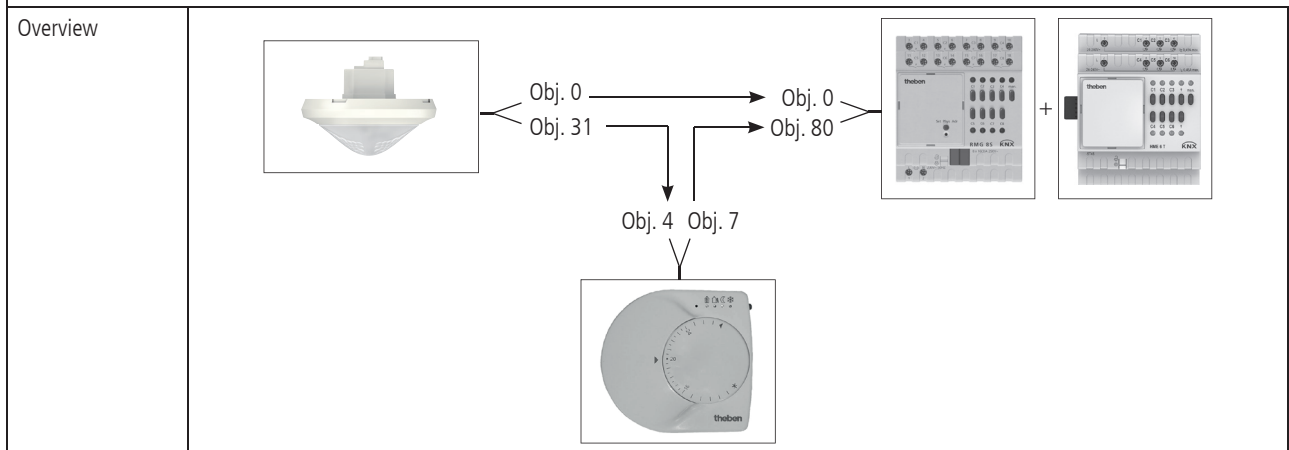

Links	thePassa P360 KNX		MiX combination		Comment
	No.	Object name / function	No.	Object name	
	0	Channel C1 light / switching	0	RMG 8 S channel C1	Switching lighting on and off
		thePassa P360 KNX	RAMSES 713 S		Comment
No.	Object name / function	No.	Object name		
	31	Channel C4.1 presence / switching	4	Presence	If the presence object is set, RAMSES 713 S changes to comfort mode.
		RAMSES 713 S		MiX combination	Comment
No.	Object name	No.	Object name		
	7	Channel 1 switching	80	EM HME 6 T channel 1	RAMSES 713 sends the actuating value for heating to the heating actuator

thePassa P360 KNX		
Parameter page	Parameter	Setting
General	Operating mode	Master
	Detection zone	Zone 1 and Zone 2 together
	Master operating mode	Individual switching
	Function channel C1 light	Switching light..
	Function channel C4 presence	active
Channel C1 - light	Configuration type	Fully automatic device
	Brightness switching value	200 lx (e.g. for corridor application)
	Lighting time delay	5 min (as per customer specification)
Channel C4 - presence	Presence switch-on delay	as per customer specification
	Presence time delay	as per customer specification
RAMSES 713 S		
Parameter page	Parameter	Setting
Operating mode	Objects for determining the operating mode	new: operating mode, presence, window status
	Operating mode after reset	Standby
	Presence sensor type (on obj. 4)	Presence detector
Heating control <sup>1)</sup>	Type of control	Continuous control
1) This setting is only required if a user-defined control is selected on the Settings parameter page.		
MIX combination RMG 8 S and extension module HME 6 T		
Parameter page	Function	Setting
General	Number of basic modules	RMG 8 S
	Type of 1st extension module	HME 6 T..
RMG 8 S channel C1: configuration options	Function	Switching on/off
HME 6 T channel H1: configuration options	Type of actuating value	continuous
Standard or customer-defined parameter settings apply to unlisted parameters.		

11.1.5 Constant lighting control

Description	Presence detectors with constant lighting control control the lighting dependent on natural daylight if the room is occupied. Artificial light is automatically dimmed up with reducing levels of daylight, and with increasing amount of daylight the artificial light automatically dims down and finally switches off. The lighting is automatically dimmed to the standby dimming value if the room is vacated.
-------------	---

Devices	thePassa P360 KNX (Order No. 2019300) DALI Gateway KNX plus (Order No. 9070929)
---------	--

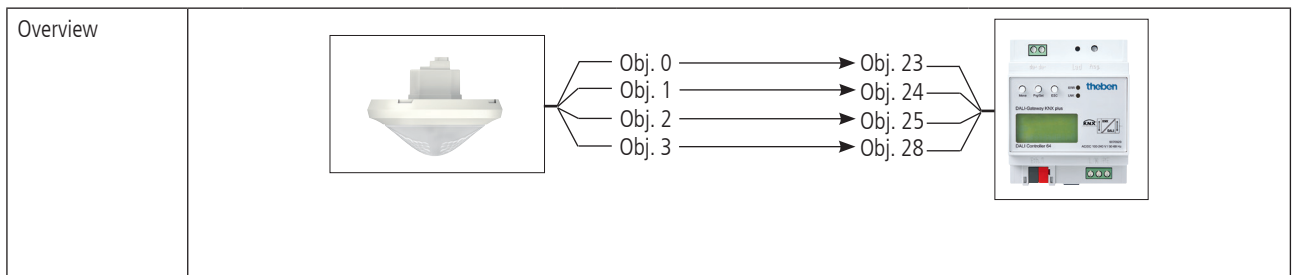

Links	thePassa P360 KNX		DALI Gateway KNX plus		Comment
	No.	Object name / function	No.	Object name / function	
	0	Channel C1 light / switching	23	Group 1 / switching	
	1	Channel C1 light / brighter/darker	24	Group 1 / dimming	
	2	Channel C1 light / send value	25	Group 1 / set value	
	3	Channel C1 light / feedback value	28	Group 1 / value	

Parameter			
thePassa P360 KNX			
Parameter page		Parameter	Setting
General		Operating mode	Master
		Detection zone	Zone 1 and Zone 2 together
		Master operating mode	Individual switching
		Function channel C1 light	Constant lighting control..
Channel C1 - light		Configuration type	Fully automatic device
		Brightness setpoint value	200 lx (e.g. for corridor application)
		Lighting time delay	5 min (as per customer specification)
Channel C1 light / detail settings		Lighting standby time	active..
DALI Gateway KNX plus			
Parameter page		Parameter	Setting
Group No. 1		Operating mode	Normal operation
		Function of additional object	no Object
		Enabled emergency/panic mode	No
Switching behaviour		Switch-on value	100%
		Switch-on behaviour	Dim to value in 10 s
		Switch-off value	0%
		Switch-off behaviour	Apply value immediately
		Behaviour on value setting	Dim to value in 10 s
		Time for dimming	10 s
		Max. value for dimming	100%
		Min. value for dimming	0%
		Switch-on via dimming	No
Standard or customer-defined parameter settings apply to unlisted parameters.			

11.1.6 Constant lighting control, additional manual override via push button

Description	<p>The presence detector controls the lighting (see example of use, page 59 chapter 11.1.5). The lighting can also be switched and dimmed manually.</p> <p>Dimming via push button ends the control. The presence detector remains at the set dimming value while the room is occupied. When the light is switched off via a push button, the lighting remains switched off as long as the presence detector detects that the room is occupied. The presence detector takes control only after the time delay has elapsed. (Only with school mode, see 2.4.6 )</p> <p>It is also possible to operate the presence detector in semi-automatic mode. In this case, the lighting must always be switched on by hand, the detector does not switch on the lighting automatically.</p>
-------------	---

Devices	<p>thePassa P360 KNX (Order No. 2019300)</p> <p>DALI Gateway KNX plus (Order No. 9070929)</p>
---------	---

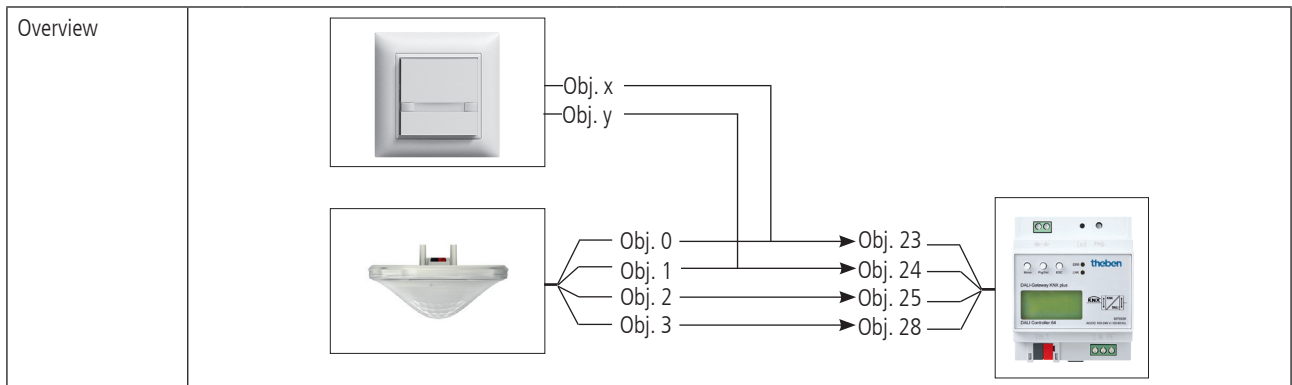

Links	thePassa P360 KNX		DALI Gateway KNX plus		Comment
	No.	Object name	No.	Object name	
	0	Channel C1 light / switching	23	Group 1 / switching	
	1	Channel C1 light / brighter/darker	24	Group 1 / dimming	
	2	Channel C1 light / send value	25	Group 1 / set value	
	3	Channel C1 light / feedback value	28	Group 1 / status value	
	any KNX push button		DALI Gateway KNX plus		Comment
	No.	Object name	No.	Object name	
	x	e.g. button 1: switching	0	Group 1 / switching	
	y	e.g. button 1: brighter/darker	2	Group 1 / dimming	Dimming via push button

thePassa P360 KNX		
Parameter page	Parameter	Setting
General	Operating mode	Master
	Detection zone	Zone 1 and Zone 2 together
	Master operating mode	Individual switching
	Function channel C1 light	Constant lighting control..
Channel C1 - light	Configuration type	Fully automatic device
	Brightness setpoint value	200 lx (e.g. for corridor application)
	Lighting time delay	5 min (as per customer specification)
Channel C1 light / detail settings	Lighting standby time	active..
<b>DALI Gateway KNX plus</b>		
Parameter page	Parameter	Setting
Group No. 1	Operating mode	Normal operation
	Function of additional object	no Object
	Enabled emergency/panic mode	no
Switching behaviour	Switch-on value	100%
	Switch-on behaviour	Dim to value in 10 s
	Switch-off value	0%
	Switch-off behaviour	Apply value immediately
	Behaviour on value setting	Dim to value in 10 s
	Time for dimming	10 s
	Max. value for dimming	100%
	Min. value for dimming	0%
	Switch-on via dimming	No
<b>KNX push button (example)</b>		
Parameter page	Parameter	Setting
Rocker 1 left	Telegram on pressing the button	On
	Telegram when released	no telegram
Rocker 1 right	Telegram on pressing the button	OFF
	Telegram when released	no telegram
Standard or customer-defined parameter settings apply to unlisted parameters.		

11.1.7 Constant lighting control with two lighting groups

Description	The constant lighting control controls the lighting dependent on natural daylight (see example 11.1.5). The lighting is divided into two lighting groups to make maximum use of the daylight near the window. The two lighting groups can be switched separately and are controlled independently.
-------------	---

Devices	thePassa P360 KNX (Order No. 2019300) DALI Gateway KNX plus (Order No. 9070929)
---------	--

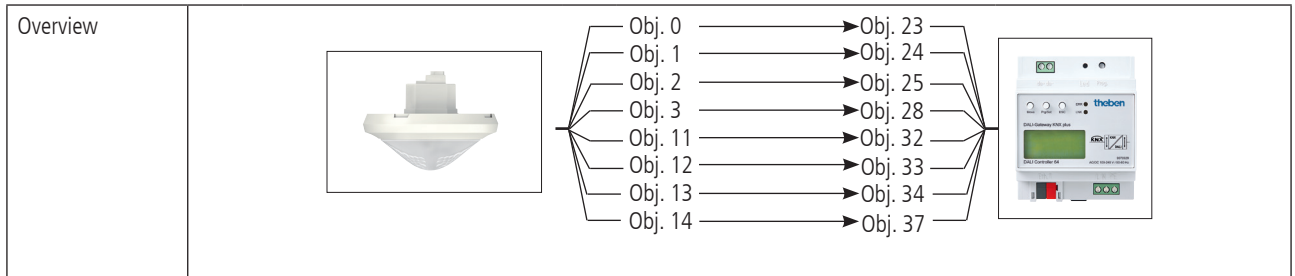

Links	thePassa P360 KNX		DALI Gateway KNX plus		Comment
	No.	Object name / function	No.	Object name / function	
	0	Channel C1 light / switching	23	Group 1 / switching	
	1	Channel C1 light / brighter/darker	24	Group 1 / dimming	
	2	Channel C1 light / send value	25	Group 1 / set value	
	3	Channel C1 light / feedback value	28	Group 1 / status value	
	11	Channel C2 light / switching	32	Group 2 / switching	
	12	Channel C2 light / brighter/darker	33	Group 2 / dimming	
	13	Channel C2 light / send value	34	Group 2 / set value	
	14	Channel C2 light / feedback value	37	Group 2 / status value	

thePassa P360 KNX				
Parameter	Parameter page	Parameter	Setting	
Parameter	General	Operating mode	Master	
		Detection zone	Zone 1 and Zone 2 separately	
		Master operating mode	Individual switching	
		Function channel C1 light	Constant lighting control..	
		Function channel C2 light	Constant lighting control..	
	Channel C1 - light	Configuration type	Fully automatic device	
		Brightness setpoint value	200 lx (e.g. for corridor application)	
		Lighting time delay	5 min (as per customer specification)	
	Channel C1 light / detail settings	Lighting standby time	active..	
	Channel C2 - light	Brightness setpoint value	200 lx (e.g. for corridor application)	
	DALI Gateway KNX plus			
	Parameter	Parameter page	Parameter	Setting
	Group No. 1		Operating mode	Normal operation
			Function of additional object	no Object
			Enabled for emergency/panic mode	No
Switching behaviour		Switch-on value	100%	
		Switch-on behaviour	Dim to value in 10 s	
		Switch-off value	0%	
		Switch-off behaviour	Apply value immediately	
		Behaviour on value setting	Dim to value in 10 s	
		Time for dimming	10 s	
		Max. value for dimming	100%	
		Min. value for dimming	0%	
		Switch-on via dimming	No	
Group No. 2		Operating mode	Normal operation	
		Function of additional object	no Object	
		Enabled for emergency/panic mode	No	
Switching behaviour		Switch-on value	100%	
		Switch-on behaviour	Dim to value in 10 s	
		Switch-off value	0%	
		Switch-off behaviour	Apply value immediately	
		Behaviour on value setting	Dim to value in 10 s	
		Time for dimming	10 s	
		Max. value for dimming	100%	
		Min. value for dimming	0%	
		Switch-on via dimming	No	
Standard or customer-defined parameter settings apply to unlisted parameters.				



11.1.8 Master/Slave parallel switching

Description	<p>A number of presence detectors can be linked together to provide coverage of large areas such as open-plan offices or corridors. One device is used as a Master, the others as Slaves.</p> <p>The Slaves trigger the Master when motion is detected. All settings, as delay times and brightness thresholds, are configured on the Master.</p> <p>Master/Slave parallel switching can be used independently of whether the Master switches one or two lighting groups or operates in constant lighting control.</p>
-------------	--

Devices	<p>thePassa P360 KNX (Order No. 2019300)</p> <p>RMG 8 S (Order No. 4930220)</p>
---------	---

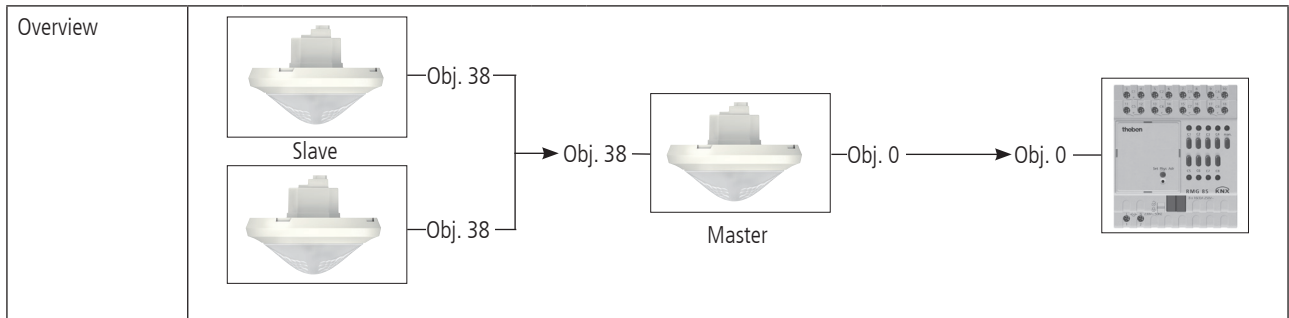

Links	thePassa P360 KNX		RMG 8 S		Comment
	No.	Object name	No.	Object name	
	0	Channel C1 light / switching	0	RMG 8 S channel 1	Switching lighting on and off
	thePassa P360 KNX (Slaves)		thePassa P360 KNX (Master)		Comment
	No.	Object name	No.	Object name	
	38	Parallel switching: trigger input/output	38	Parallel switching: trigger input/output	Connection between Master and Slave

Parameter	thePassa P360 KNX (Master)		
	Parameter page	Parameter	Setting
General	Operating mode	Master	
	Detection zone	Zone 1 and Zone 2 together	
	Master operating mode	Parallel switching	
	Function channel C1 light	Switching light..	
Channel C1 - light	Configuration type	Fully automatic device	
	Brightness setpoint value	200 lx (e.g. for corridor application)	
	Lighting time delay	5 min (as per customer specification)	
	thePassa P360 KNX (Slaves)		
	Parameter page	Parameter	Setting
General	Operating mode	Slave	
	RMG 8 S		
	Parameter page	Parameter	Setting
RMG 8 S channel C1: configuration options	Channel function	Switching on/off	
	Standard or customer-defined parameter settings apply to unlisted parameters.		

11.1.9 Master/Master parallel switching

Description	<p>A number of Master presence detectors can be connected together to cover large areas with varying lighting conditions such as open-plan offices.</p> <p>Each Master operates its lighting group according to its measurements and settings. They exchange presence among each other. This extends the detection area. Master/Master parallel switchings permit several lighting groups to operate with their own light measurement. It should be noted that every Master can only detect light switched or controlled by itself.</p> <p>Master/Master parallel switching can be used independently of whether the Master is configured for switching or constant lighting control.</p>
-------------	---

Devices	<p>thePassa P360 KNX (Order No. 2019300)</p> <p>RMG 8 S (Order No. 4930220)</p>
---------	---

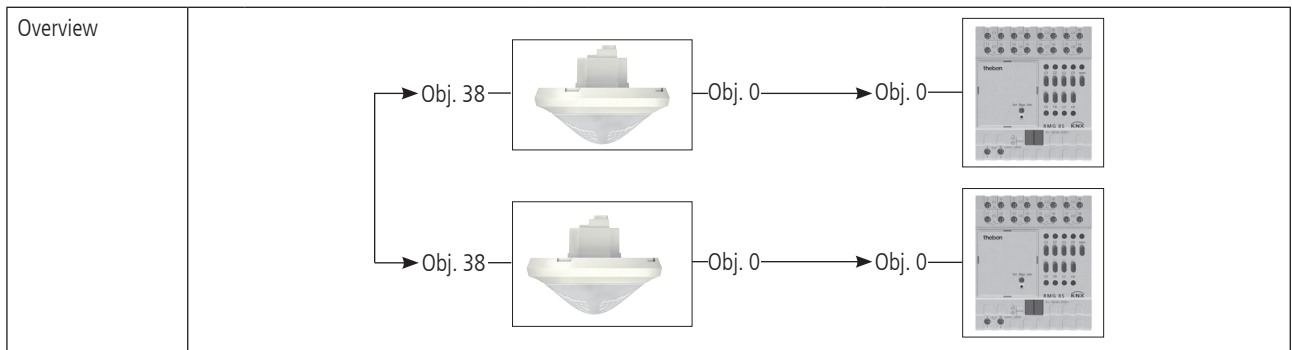

Links	thePassa P360 KNX		RMG 8 S		Comment
	No.	Object name / function	No.	Object name	
	0	Channel C1 light / switching	0	RMG 8 S channel 1	Switching lighting on and off
	thePassa P360 KNX		thePassa P360 KNX		Comment
	No.	Object name	No.	Object name	
	38	Parallel switching: trigger input/output	38	Parallel switching: trigger input/output	Connection between Master and Master

Parameter	thePassa P360 KNX		
	Parameter page	Parameter	Setting
General	Operating mode	Master	
	Detection zone	Zone 1 and Zone 2 together	
	Master operating mode	Parallel switching	
	Function channel C1 light	Switching light..	
Channel C1 - light	Configuration type	Fully automatic device	
	Brightness setpoint value	200 lx (e.g. for corridor application)	
	Lighting time delay	5 min (as per customer specification)	
	RMG 8 S		
	Parameter page	Parameter	Setting
	RMG 8 S channel C1: configuration options	Channel function	Switching on/off
Standard or customer-defined parameter settings apply to unlisted parameters.			

11.1.10 Aura effect

Description	<p>During the aura effect, the light surrounds the user while he is moving. The lighting in the adjacent detection areas is switched or dimmed to the &lt;Aura dimming value&gt;. It follows an example of 3 presence detectors and 6 lighting groups.</p> <p>Procedure:</p> <ol style="list-style-type: none"> <li>① Make settings at Master A, B and C.</li> <li>② Assign an own group address to aura effect object 1/2 (Master A, B and C).</li> <li>③ Interconnect the own aura effect objects at each Master. Example: Connect object 38 with object 39 and object 39 with object 38.</li> <li>④ Connect the aura effect objects of the adjacent zones of the individual Master devices. Example: Connect Master A, object 39 with Master B, object 38.</li> </ol>
-------------	--

Devices	<p>thePassa P360 KNX (Order No. 2019300) Master A, B and C.          DALI Gateway KNX plus (Order No. 9070929)</p>
---------	--

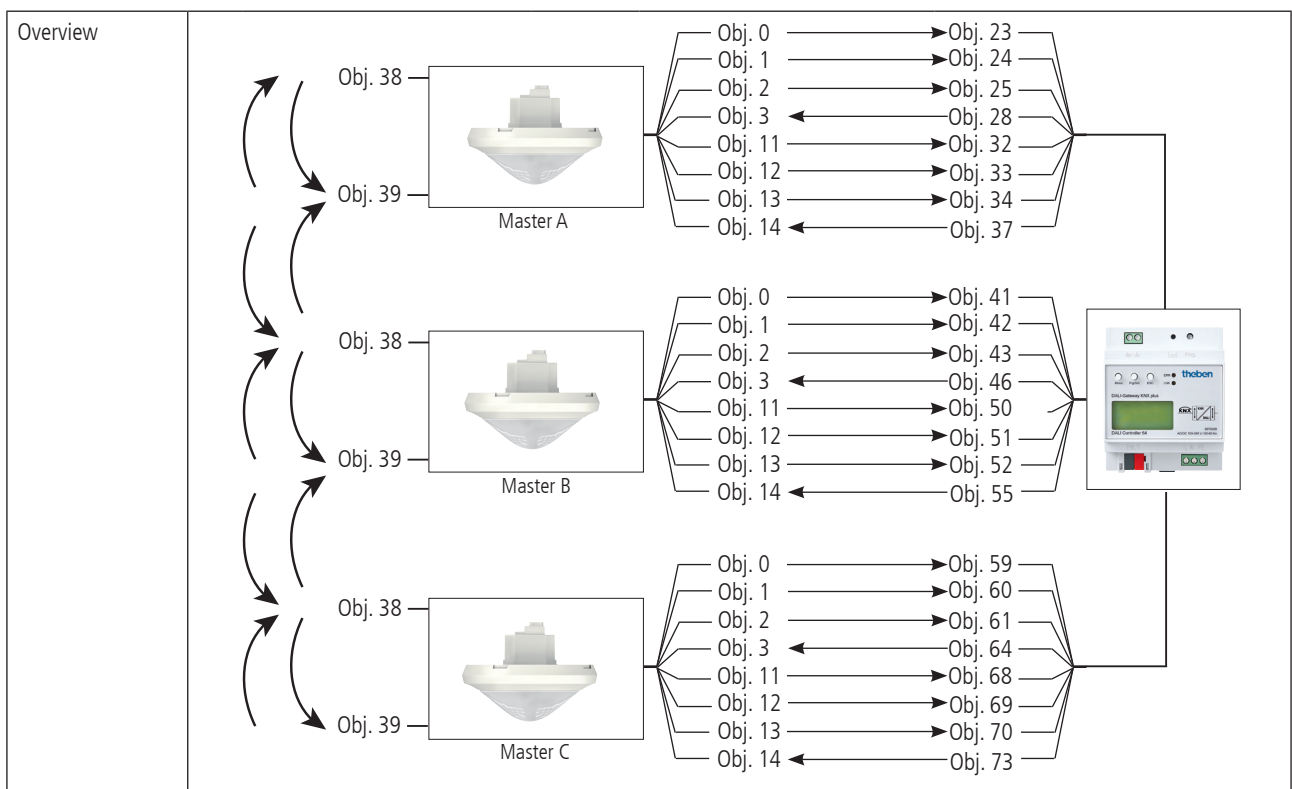

Links	thePassa P360 KNX / Master A, B, C		DALI Gateway KNX plus		Comment
	No.	Object name / function	No.	Object name / function	
	0	Channel C1 light / switching	23/41/59	Group 1,3,5 / switching	
	1	Channel C1 light / brighter/darker	24/42/60	Group 1,3,5 / dimming	
	2	Channel C1 light / send value	25/43/61	Group 1,3,5 / set value	
	3	Channel C1 light / feedback value	28/46/64	Group 1,3,5 / status value	
	11	Channel C2 light / switching	32/50/68	Group 2,4,6 / switching	
	12	Channel C2 light / brighter/darker	33/51/69	Group 2,4,6 / dimming	
	13	Channel C2 light / send value	34/52/70	Group 2,4,6 / set value	
	14	Channel C2 light / feedback value	37/55/73	Group 2,4,6 / status value	

Links ③	thePassa P360 KNX / Master A		thePassa P360 KNX / Master A		Comment
	No.	Object name / function	No.	Object name / function	
	38	Channel C1 - light aura effect	39	Channel C2 - light aura effect	Object links Master A
	39	Channel C2 - light aura effect	38	Channel C1 - light aura effect	

Links ③	thePassa P360 KNX / Master B		thePassa P360 KNX / Master B		Comment
	No.	Object name / function	No.	Object name / function	
	38	Channel C1 - light aura effect	39	Channel C2 - light aura effect	Object links Master B
	39	Channel C2 - light aura effect	38	Channel C1 - light aura effect	

Links ③	thePassa P360 KNX / Master C		thePassa P360 KNX / Master C		Comment
	No.	Object name / function	No.	Object name / function	
	38	Channel C1 - light aura effect	39	Channel C2 - light aura effect	Object links Master C
	39	Channel C2 - light aura effect	38	Channel C1 - light aura effect	

Links ④	thePassa P360 KNX / Master A		thePassa P360 KNX / Master B		Comment
	No.	Object name / function	No.	Object name / function	
	39	Channel C2 - light aura effect	38	Channel C1 - light aura effect	Object links Master A - Master B

Links ④	thePassa P360 KNX / Master B		thePassa P360 KNX / Master A		Comment
	No.	Object name / function	No.	Object name / function	
	38	Channel C1 - light aura effect	39	Channel C2 - light aura effect	Object links Master B - Master A

Links ④	thePassa P360 KNX / Master B		thePassa P360 KNX / Master C		Comment
	No.	Object name / function	No.	Object name / function	
	39	Channel C2 - light aura effect	38	Channel C1 - light aura effect	Object links Master B - Master C

Links ④	thePassa P360 KNX / Master C		thePassa P360 KNX / Master B		Comment
	No.	Object name / function	No.	Object name / function	
	38	Channel C1 - light aura effect	39	Channel C2 - light aura effect	Object links Master C - Master B

thePassa P360 KNX				
Parameter	Parameter page	Parameter	Setting	
General	General	Operating mode	Master	
		Detection zone	Zone 1 and Zone 2 separately	
		Master operating mode	Aura effect	
		Function channel C1 light	Constant lighting control..	
		Function channel C2 light	Constant lighting control..	
	Channel C1 - light	Channel C1 - light	Configuration type	Fully automatic device
			Brightness setpoint value	200 lx (e.g. for corridor application)
			Lighting time delay	5 min (as per customer specification)
	Channel C1 light / detail settings	Channel C1 light / detail settings	Lighting standby time	active..
	Channel C2 - light	Channel C2 - light	Brightness setpoint value	200 lx (e.g. for corridor application)
DALI Gateway KNX plus				
Parameter	Parameter page	Parameter	Setting	
Group No. 1,2,3,4,5 and 6	Group No. 1,2,3,4,5 and 6	Operating mode	Normal operation	
		Function of additional object	No object	
		Enabled for emergency/panic mode	No	
Switching behaviour	Switching behaviour	Switch-on value	100%	
		Switch-on behaviour	Dim to value in 10 s	
		Switch-off value	0%	
		Switch-off behaviour	Apply value immediately	
		Behaviour on value setting	Dim to value in 10 s	
		Time for dimming	10 s	
		Max. value for dimming	100%	
		Min. value for dimming	0%	
Switch-on via dimming	No			
Standard or customer-defined parameter settings apply to unlisted parameters. Bear in mind the direction of the light measurement, see installation manual.				

## Contact

Theben AG  
 Hohenbergstr. 32  
 72401 Haigerloch  
 GERMANY  
 Phone +49 7474 692-0  
 Fax +49 7474 692-150

Hotline  
 Phone +49 7474 692-369  
 hotline@theben.de  
 Addresses, telephone numbers, etc.  
 www.theben.de